

# Super 60m XHD TallTower™ Installation & Specifications

USER'S MANUAL



**NRG**Systems™

110 Riggs Road  
Hinesburg, VT 05462 USA  
support@nrgsystems.com  
+1 802.482.2255 | nrgsystems.com



© NRG Systems, Inc.  
110 Riggs Road  
Hinesburg VT 05461 USA  
Tel: 802-482-2255  
Fax: 802-482-2272  
[sales@nrgsystems.com](mailto:sales@nrgsystems.com)  
[support@nrgsystems.com](mailto:support@nrgsystems.com)  
[www.nrgsystems.com](http://www.nrgsystems.com)

Specifications are subject to change without notice.



## Table of Contents

<b>Chapter 1: Safety Considerations .....</b>	<b>7</b>
1.1 WARNINGS .....	7
<b>1.2 SAFETY CONSIDERATIONS: ANSI Z535.5.....</b>	<b>8</b>
1.3 SAFETY BULLETIN FOR TOWER INSTALLATIONS IN AGRICULTURAL AREAS or remote areas where low flying aircraft operate .....	10
<b>1.4 Tower Obstruction Marking .....</b>	<b>11</b>
1.5 References .....	12
<b>Chapter 2: Pre-Installation Guidelines.....</b>	<b>12</b>
2.1 TallTower History .....	12
2.2 Construction and Assembly .....	12
2.3 Required Parts to Erect Tower System .....	12
2.4 Experience Required .....	13
2.5 TOWER LIFT CREW .....	13
2.6 Using This Manual .....	14
recommendation: .....	14
2.7 Tools.....	14
2.7.1 TOOLS SUPPLIED WITH TOWER KITS.....	14
2.7.2 Tools Supplied with Installation Toolkit #4832 .....	15
2.7.3 Tools Required but not Supplied.....	15
2.8 Unpack your tower .....	16
2.8.1 Description of the Envirocrate packaging .....	16
2.8.2 Tools required to unpack the Envirocrate.....	17
2.8.3 EnviroCrate Access and Orientation .....	17
2.8.4 Envirocrate Unpack Sequence – Very Important!.....	17
2.9 Site Layout.....	20
2.9.1 Pre-installation Planning .....	20
2.9.2 Soil Type and Anchors .....	20
Tip: Cellular Coverage.....	21
2.10 Site Layout Map .....	21
2.11 Connect the Curtis Bridle Assembly to the 3 block pulley anchors .....	27
<b>Chapter 3: Tower Components Assembly .....</b>	<b>28</b>
3.1 Assemble the Baseplate .....	28
3.2 Assemble Cable from Baseplate to 8” Screw-in Anchor .....	34
3.3 Install the Anchors .....	35
3.4 Tube Layout.....	35
3.5 Install the Tower Base Tube .....	37
3.6 Attach the Lightning Spike .....	44
3.7 Attach sensors and booms.....	46
3.8 Spiral wrap your sensor cables .....	47
3.9 Attach the Guy Wires.....	47



- 3.9.1 Organize and layout the lifters and guy wires..... 47
- 3.9.2 Guy wire roll out sequence ..... 48
- 3.9.3 Shackle lifter wires to the guy rings ..... 48
- 3.9.4 Back Guy Wire Marking Distance From Guy Level ..... 49
- 3.9.5 Roll out guy wires ..... 50
- 3.9.6 Secure guy wires to the anchors ..... 51
- 3.10 Ginpole Assembly..... 53
  - 3.10.1 Layout the ginpole tubes..... 53
  - 3.10.2 Attach the ginpole base tube to the baseplate..... 53
  - 3.10.3 Slide together the 10 tubes that comprise the ginpole ..... 53
  - 3.10.4 Attach the ginpole jumper strut end-flanges..... 54
  - 3.10.5 Attach the turnbuckles to the end-flanges ..... 56
  - 3.10.6 Attach the ginpole jumper struts ..... 56
  - 3.10.7 Attach the ginpole jumper strut cables..... 59
  - 3.10.8 Attach the ginpole top mounting hardware ..... 61
  - 3.10.9 Attach the Lifter Wires & Front Guy Wires ..... 63
  - 3.10.10 Critical Installation Step: Attach the pulley blocks to the ginpole ..... 66
  - 3.10.11 Configure the helper ginpole ..... 67
  - 3.10.12 Connect the Curtis Bridle Assembly to the 3 block pulley anchors ..... 70
  - 3.10.12 Setting up the winch and hydraulic power unit (HPU). ..... 70
    - 3.10.13 Anchor the winch ..... 73
    - 3.10.14 Reeving the winch cable..... 74
    - 3.10.15 Critical Installation Step: Tensioning the ginpole jumper strut cables..... 79

**Chapter 4: Installation Process ..... 81**

- 4.1 Ginpole Tilt-Up ..... 81
  - 4.1.1 Confirm all guy wires, lifters and shackles are secure ..... 81
  - 4.1.2 Lift the ginpole ..... 82
- 4.2 Tower Tilt-Up ..... 83
  - 4.2.1 Understanding Guy Wire Tensioning DURING TallTower LIFT (Do not raise the tower yet) 83
  - 4.2.2 Adjusting Guy Wires ..... 84
  - 4.2.3 Loosening Guy Wires..... 84
  - 4.2.4 Tightening Guy Wires ..... 85
  - 4.2.5 Monitor the weather..... 85
- 4.3 Lifting the tower ..... 85
  - 4.3.1 Phase 1: Tower Lift from 0° to 60° ..... 85
  - 4.3.2 Critical Installation Step: Permissible Deflection ..... 86
  - 4.3.3 Phase 2: Tower Lift from 60° to 90° using the Back Stay Tensioning System ..... 87
- 4.4 Attaching Front Guy Wires..... 88
- 4.5 Plumb and Straighten Tower ..... 88
  - 4.5.1 Guy Tension Check ..... 89
    - Critical Installation Step: Guy Tension Measurement Methods ..... 90
      - 4.5.1.1 Pulse Method ..... 90
      - 4.5.1.2 Tangent Intercept Method ..... 92
- 4.6 Transfer Lifters ..... 95
- 4.7 Final Inspection and Maintenance ..... 98



<b>Chapter 5: Tower Lowering</b> .....	<b>101</b>
5.1 Tower Lowering Overview .....	101
5.1.1 Critical Installation Step: Tensioning the ginpole jumper strut cables.....	101
5.1.2 Critical Installation Procedure: Utilize the Back Stay Tensioning System .....	102
5.1.3 Phase 1: Tower Lowering from 90° to 60° (Max tension on back stay tensioning system = 150 lbf.) .....	102
5.1.3 Tower Lowering from 80° to 60° .....	102
5.1.4 Phase 2: Tower Lowering from 60° to 0° .....	103
<b>Appendix A: Super 60 m XHD TallTower with Standard Footprint                      Tower Layout</b> .....	<b>104</b>
Site Layout.....	105
Table A-1: Tower Erection Forces (tower only) .....	106
Table A-2 Tower Erection Forces (with typical NOW System – 3 booms at 30 m, 3 booms at 40 m, 3 booms at 58 m) .....	106
Code Compliance Curve – SI Units .....	110
Anchor Loads – Imperial Units (The loads shown on the graph apply to each of the anchors) .....	113
Anchor Loads - SI Units (The loads shown on the graph apply to each of the anchors) .....	114
Baseplate Loads – Imperial Units.....	115
Baseplate Loads – SI Unit.....	116
<b>Appendix B: Anchoring Guidelines</b> .....	<b>117</b>
B.1 Determine site soil and anchor type before you order your tower .....	117
B.2 Anchor Choices and other considerations .....	118
B.3 Screw-In Anchor Description.....	118
B.4 ROCK ANCHOR DESCRIPTION.....	119
B.5 Installing Screw-In Anchors.....	119
B.6 Installing 8 inch diameter twin helix anchors .....	120
B.7 Installing Rock Anchors .....	121
<b>Appendix C: Site Visit Procedures</b> .....	<b>122</b>
C.1 Site Checklist .....	122
<b>Appendix D: Super 60 m XHD TallTower Painted Version</b> .....	<b>123</b>
<b>Appendix E: NRG Super 60 &amp; 80m XHD TallTower Back Guywire Tensioner Assembly and Operating Instructions</b> .....	<b>124</b>
E.1 Introduction .....	124
E.2 Back Guywire Tensioner System Overview .....	124
E.3 Back Guywire Tensioner Assembly .....	127
E.4 Tower Lift .....	129
E.4.1 Phase 1: Tower Lift from 0° to 60° .....	130
E.4.2 Phase 2: Tower Lift from 60° to 90° .....	130
E.4.3 Lift-Cycle Instructions .....	133
E.4.4 Attach the Front Guys .....	135
E.4.5 Plumb and Straighten Tower.....	135
E.5 Lowering the tower .....	135



**Appendix F: 2.4 m (95") Side Mount Boom Installation ..... 136**  
F.1 Introduction..... 136  
F.2 Installation..... 136

**Appendix G: ANSI/TIA-222-G Foundation Considerations ..... 141**  
Baseplate Geometry (with ground surface area of 19.5 ft<sup>2</sup>) ..... 141



## Chapter 1: Safety Considerations

### 1.1 WARNINGS

#### ALWAYS DO THE FOLLOWING:

- Only install or remove TallTowers using experienced installation crew members who are familiar with all TallTower components and safe installation and removal procedures.
- Always follow all instructions and warnings in the TallTower Installation Manual, as well as all other technical information necessary for the safe installation in a specific location.
- Always consult with appropriate professionals to determine soil type at the installation site and then the most appropriate anchor system for use at that site. Follow all anchor instructions in this manual or manufacturers' instructions if using a different anchor than we provide.
- Always stand to the side of any guy wire under tension so that you are not in the path of a guy wire that breaks or comes loose.
- Always consult with appropriate authorities (*e.g.*, the Federal Aviation Administration, local building or zoning departments, etc.) and surrounding land owners if a TallTower is being installed in an agricultural area to determine installation and tower marking requirements so as to minimize risk to low flying agricultural aircraft.







#### NEVER DO THE FOLLOWING:

- Never begin an installation with an inexperienced or untrained installation crew.
- Never allow installation crew members to commence work unless and until each crew member has thoroughly read and understands the information contained in the TallTower Installation Manual.
- Never stand in a direct line with any guy wire under tension as it could cause serious injury or death if it breaks or comes loose.
- Never climb a TallTower.
- Never erect a TallTower in an area where electrical power lines pose a hazard.
- Never allow unauthorized persons in the area where a TallTower is being installed.
- Never begin or continue a TallTower installation during high winds greater than 10-15 mps.







- Never begin or continue a TallTower installation during an electrical storm or when one is imminent.
- Never use parts for one TallTower to create a shorter TallTower; this cannot be done safely.

## 1.2 SAFETY CONSIDERATIONS: ANSI Z535.5

Critical Installation Step	A step in the installation process that must be completed correctly. Failure to follow critical installation steps precisely may result in catastrophic failure of the ginpole or tower and endanger the lives of crew members.
	<ul style="list-style-type: none"> <li>• <b>Attention:</b> Very important step, please read closely and follow directions.</li> </ul>
	<ul style="list-style-type: none"> <li>• <b>Warning:</b> Indicate[s] a hazardous situation which, if not avoided, could result in death or serious injury. WARNING [signs] should not be used for property damage hazards unless personal injury risk appropriate to this level is also involved.</li> </ul>
	<ul style="list-style-type: none"> <li>• <b>Danger:</b> Indicate[s] a hazardous situation which, if not avoided, will result in death or serious injury. The signal word "DANGER" is to be limited to the most extreme situations. DANGER [signs] should not be used for property damage hazards unless personal injury risk appropriate to these levels is also involved</li> </ul>
	<ul style="list-style-type: none"> <li>• <b>Caution:</b> Indicate[s] a hazardous situation which, if not avoided, could result in minor or moderate injury. CAUTION [signs] without a safety alert symbol may be used to alert against unsafe practices that can result in property damage only.</li> </ul>
	<ul style="list-style-type: none"> <li>• <b>Notice:</b> [this header is] preferred to address practices not related to personal injury. The safety alert symbol shall not be used with this signal word. As an alternative to "NOTICE" the word "CAUTION" without the safety alert symbol may be used to indicate a message not related to personal injury.</li> </ul>
	<b>READ ALL INSTRUCTIONS AND WARNINGS BEFORE BEGINNING ANY TOWER INSTALLATION. TOWER COMPONENTS CONSIST OF HEAVY OBJECTS OFTEN UNDER SIGNIFICANT TENSION AND SERIOUS INJURY OR DEATH CAN OCCUR IF EXTREME CAUTION IS NOT USED DURING EVERY ASPECT OF THE INSTALLATION. EVERY INSTALLATION CREW MEMBER SHOULD CAREFULLY READ AND UNDERSTAND ALL WARNINGS, INSTRUCTIONS AND OTHER INFORMATION IN THIS INSTALLATION MANUAL, INCLUDING THE GLOSSARY OF TERMS.</b>
	<b>ONLY EXPERIENCED INSTALLERS SHOULD PERFORM TALLTOWER INSTALLATIONS. DO NOT ATTEMPT TO INSTALL A TALLTOWER IF YOU ARE INEXPERIENCED OR UNTRAINED. TALL, GUYED TOWERS AND THEIR COMPONENTS CAN POSE DANGERS THAT CAN LEAD TO SERIOUS INJURY OR DEATH TO YOU OR OTHERS AROUND YOU. DO NOT BEGIN A TALLTOWER INSTALLATION UNLESS YOU HAVE ASSEMBLED AN EXPERIENCED AND QUALIFIED CREW.</b>





 <b>WARNING</b>	<p><b>USE ONLY SUITABLE TOWER ANCHORS FOR THE SOIL TYPE AT THE INSTALLATION SITE.</b> THE LIMIT LOADS OF THE COMPLETED TOWER UNDER VARYING CONDITIONS (<i>E.G.</i>, HIGH WINDS AND ICE), AND THE STRENGTH DURING INSTALLATION DEPENDS ON THE USE OF PROPER ANCHORS FOR THE SOIL TYPE AT THE INSTALLATION SITE. FAILURE TO USE PROPER ANCHORS COULD CAUSE THE TOWER TO FALL RESULTING IN SERIOUS INJURY OR DEATH OR PROPERTY DAMAGE. CONSULT WITH THE APPROPRIATE PROFESSIONALS TO FIRST DETERMINE SOIL CONDITIONS AND THEN DESIGN THE PROPER ANCHOR SYSTEM BEING SURE TO FOLLOW ALL ANCHOR MANUFACTURERS' INSTRUCTIONS.</p>
 <b>DANGER</b>	<p><b>DO NOT INSTALL A TALLTOWER NEAR ELECTRICAL POWER LINES.</b> METAL TALLTOWER COMPONENTS EFFICIENTLY CONDUCT ELECTRICAL CURRENT AND CAN RESULT IN SERIOUS INJURY OR DEATH IF THEY COME IN CONTACT WITH HIGH VOLTAGE ELECTRICAL LINES. SURVEY THE PROPOSED INSTALLATION SITE AND DO NOT BEGIN ANY TALLTOWER INSTALLATION IF ANY ELECTRICAL LINES ARE PRESENT.</p>
 <b>DANGER</b>	<p><b>DO NOT BEGIN OR CONTINUE A TALLTOWER INSTALLATION DURING AN ELECTRICAL STORM.</b> IF LIGHTNING STRIKES A TALLTOWER OR ITS METAL COMPONENTS, SERIOUS INJURY OR DEATH COULD OCCUR TO THOSE WORKING WITH OR AROUND IT. DO NOT BEGIN AN INSTALLATION, OR CONTINUE ONE, DURING AN ELECTRICAL STORM OR IF ONE IS IMMINENT.</p>
 <b>WARNING</b>	<p>WEAR APPROPRIATE PROTECTIVE GEAR AND USE CAUTION WHEN UNPACKING TALLTOWER COMPONENTS. WEAR GLOVES AND EYE PROTECTION WHILE UNPACKING THE ENVIROCRATE TO PREVENT CUTS AND OTHER INJURIES FROM BANDS AND SHARP OBJECTS. HEAVY COMPONENTS CAN SHIFT IF NOT UNPACKED CAREFULLY AND IN THE PROPER SEQUENCE. FOLLOW ALL UNPACKING INSTRUCTIONS.</p>
	<p><b>CARELESSNESS DURING TOWER INSTALLATION CAN CAUSE SERIOUS INJURY OR DEATH.</b> AN IMPROPERLY INSTALLED TALLTOWER CAN ALSO CAUSE SERIOUS INJURY OR DEATH. FOR YOUR SAFETY AND THE SAFETY OF OTHERS ON THE INSTALLATION CREW, AS WELL AS THOSE IN THE VICINITY OF A COMPLETED TOWER.</p>



### 1.3 SAFETY BULLETIN FOR TOWER INSTALLATIONS IN AGRICULTURAL AREAS OR REMOTE AREAS WHERE LOW FLYING AIRCRAFT OPERATE



**ALWAYS USE VISIBILITY ENHANCING DEVICES ON TALLTOWERS INSTALLED IN AGRICULTURAL AREAS WHERE LOW FLYING AIRCRAFT OPERATE.** The installation of TallTowers in agricultural areas can pose a serious risk to low-flying aircraft. **Physical contact between an agricultural aircraft and any part of a TallTower or its guy wire system can result in serious injury or death.** It is therefore imperative that landowners, developers, wind energy consultants and installers each consider this serious safety risk for any wind energy project proposed for installation in an agricultural area

NRG Systems manufactures FAA compliant painted towers for use in agricultural areas. In addition, a variety of visibility enhancement accessories, including FAA compliant aviation obstruction lighting kits, high visibility cable ball kits, and guy wire guards, are available from NRG Systems for use with such installations.

If the installation of an MET is being proposed for an agricultural area or in remote areas where low flying aircraft operate, NRG Systems strongly recommends those involved in the project do ALL of the following:

Become familiar with any and all applicable Federal Aviation Administration (FAA) tower visibility and lighting requirements, including FAA Advisory Circular AC 70/7460-1L “Obstruction Marking and Lighting” dated October 8, 2016 and as revised, and ensure the installation complies with those standards and any recommendations contained therein, including but not limited to the following:

- a. Voluntary marking of meteorological towers less than 200 feet (61 m) AGL in accordance with marking guidance contained in the FAA Advisory Circular AC70/7460-1L.
- b. Painting with alternate bands of aviation orange and white paint in accordance with Chapter 3, paragraphs 3.1 through 3.4 of the FAA Advisory Circular AC70/7460-1L.
- c. Utilizing several high visibility sleeves (guy guards) on outer guy wires.
- d. Attaching spherical marker (cable) balls to the guy wires. Aviation orange marker balls should be installed according to Chapter 3, paragraph 3.5 of the FAA Advisory Circular AC70/7460-1L;

Contact the FAA’s Obstruction Evaluation/Airport Airspace Analysis (OE/AAA) office (<http://oaaaa.faa.gov>) to discuss whether a “Notice of Proposed Construction or Alteration” form (FAA Form 7460-1) is required;



Contact the nearest FAA Regional or District Office regarding installation reporting requirements ([www.faa.gov/airports/news\\_information/contact\\_info/?s](http://www.faa.gov/airports/news_information/contact_info/?s))

Become familiar with any and all state and local statutes, ordinances, zoning or other regulations regarding tower visibility and lighting requirements, as some states have enacted statutes or regulations – as have many local jurisdictions – which may affect tower visibility and lighting and which may differ from FAA requirements;

Contact local regulatory agencies (*e.g.*, city and county building departments) to determine if there are any local zoning regulations relating to the installation;

Investigate whether agricultural aviation is present at or around the installation site(s) under consideration, including contacting state and local farm bureaus and/or state or national agricultural aviation organizations (*e.g.*, National Agricultural Aviation Association [<http://www.agaviation.org>]), and; Contact local landowners, farming operations and agricultural operators and notify them of a proposed or completed installation, including specific GPS coordinates.

## 1.4 Tower Obstruction Marking

Super 60m XHD painted towers meet the requirements of Federal Aviation Administration (FAA) Advisory Circular AC 70/7460-1L for Obstruction Marking and Lighting. The paint color used for obstruction marking complies with Federal Standard FED-STD-595 and the paint coating passes ASTM D3359 Standard Test Methods for Measuring Adhesion by Tape Test. Although the paint coating passes a rigorous adhesion test and great care is taken to minimize damage, scuff marks, paint chipping, and blemishes do occur to the finish during manufacturing and transportation. Although coating damage may occur, the paint finish achieves its design objective of providing obstruction marking in accordance with the FAA Advisory Circular AC 70/7460-1L for Obstruction Marking and Lighting.



**ALWAYS USE VISIBILITY ENHANCING DEVICES ON TALLTOWERS INSTALLED IN AGRICULTURAL AREAS WHERE LOW FLYING AIRCRAFT OPERATE.** The installation of talltowers in agricultural areas can pose a serious risk to low-flying aircraft. **Physical contact between an agricultural aircraft and any part of a talltower or its guy wire system can result in serious injury or death.** Consult appropriate authorities for guidance on the use of painted towers, tower lighting, high visibility guy wire balls, and/or guy guards for such installations.



## 1.5 REFERENCES

ANSI/TIA-222-G Structural Standard for Antenna Supporting Structures and Antenna  
ASTM D3359 - 09e2 Standard Test Methods for Measuring Adhesion by Tape Test  
Encyclopedia of Anchoring - Principles and Applications of Anchoring, Hubbell Power Systems  
Federal Aviation Administration (FAA) Advisory Circular AC 70/7460-1L  
Federal Specification FED-STD-595  
Federal Specification Wire Rope and Strand RR-W-410F

## Chapter 2: Pre-Installation Guidelines

### 2.1 TALLTOWER HISTORY

NRG TallTowers™, the original tilt-up tubular towers, were first introduced in 1982 and before long became the industry standard to quickly and easily get sensors up and into the wind to start measurements. TallTowers are delivered in complete kits, assembled on the ground and then tilted up and secured with guy wires. The Super 60 meter XHD TallTower is ice-rated for extreme climates and meets the applicable sections of ANSI/TIA-222-G Standards.

### 2.2 CONSTRUCTION AND ASSEMBLY

The NRG TallTower™ is constructed of galvanized steel tube and is guyed at six levels in four directions. Sections slide together and are secured using fasteners. The tower is tilted up from the ground with a gin pole and winch (not included). Lifting of the tower is accomplished using six lifting wires attached to the gin pole. The tower is stabilized using four guy wire sets. The base plate is hinged so both the tower and ginpole can pivot to the erected position.

### 2.3 REQUIRED PARTS TO ERECT TOWER SYSTEM

NRG Super 60 meter XHD TallTowers are supplied complete with ready to assemble tubes, baseplate, guy rings, precut guy wires, grounding kit, and associated hardware. Anchors are optional. Several types of anchors, suitable for many soil types, are available from NRG. It is your responsibility to determine which type of anchor is appropriate for your specific site.

Please refer to *Appendix B: Anchoring Guidelines* of this manual for more information.

A winch and ginpole are required to raise the tower. When combined, a winch and ginpole comprise an installation kit. The installation kit can be transported from one site to another to raise and lower the Super 60m XHD TallTower. The winch and ginpole for the Super 60 m XHD TallTower are the same equipment used to raise and lower the NRG 80m XHD TallTower, and, therefore, can be used to erect and lower the NRG 80m XHD TallTower. The ginpole for the Super



60m TallTower are NOT compatible with the NRG 50m XHD and 60m XHD TallTowers and SHALL NOT be used to raise and lower these towers.

The Back Stay Tensioning System is also required to raise the Super 60 meter tower. Please refer to [Appendix E: NRG Super 60 & 80m XHD TallTower Back Guywire Tensioner Assembly and Operating Instructions](#).

## 2.4 EXPERIENCE REQUIRED



Extensive experience installing other TallTowers is required for successful installation of the Super 60 m XHD TallTower. If you do not have extensive experience installing TallTowers, seek assistance from a qualified installer.

**Contact NRG Systems for referral to qualified installers.**

## 2.5 TOWER LIFT CREW

We suggest the following organization to form an efficient and safe crew to erect NRG TallTowers. Each member of the lift crew should have a good understanding of the tasks they are required to perform during the lift.

1. “Qualified Installer” Defined: As used herein, the term “Qualified Installer” is defined as a person or entity that meets the following criteria:
    - a. A Team Leader or Foreman who has successfully supervised the installation of at least 20 NRG 60m XHD TallTowers, the most recent of which was within the last 3 years **AND** has been trained by NRG Systems **AND** utilizes a Crew/Team of at least 6 people who have **each** assisted with the installation of at least 3 tilt-up towers.

OR

  - b. A Team Leader or Foreman who has successfully supervised the installation of at least 2 NRG 80m XHD TallTowers, the most recent of which was within the last 3 years, **AND** has been trained by NRG Systems **AND** utilizes a Crew/Team of at least 6 people who have **each** assisted with the installation of at least 3 tilt-up towers.
- OR
- c. A Team Leader or Foreman of an installation crew who is a Renewable RNG Systems employee who has been trained and has field experience in the installation, raising and lower of all models of NRG TallTowers.



Six (6) Member Crew (MINIMUM):

Crew leader (1): This person will coordinate the other members. It is especially important to maintain clear communication among the members of the crew. The tower footprint is large and walkie-talkie radios are highly recommended.

Winch operator (1): This person operates the winch and HPU, following the direction given by the crew leader.

Side guy wire tenders (4): Four (4) people to assist adjusting side guy wires (two (2) on each side). They must be familiar with taking in and letting out guy wire tension. See 4.3 Lifting the tower for details. See the section entitled [Adjusting Guy Wires](#) for details on adjusting guy wires.

**Depending on the site terrain and other factors, it may be more efficient to have a larger crew than to reallocate members of a smaller crew. Plan accordingly and contact NRG Systems with any questions regarding crew size.**

## 2.6 USING THIS MANUAL

The single configuration for the Super 60 m XHD TallTower consists of a 59.8 m height and a single guy anchor footprint. This manual provides detailed information on the installation and specifications of the Super 60m XHD TallTower. Wind and ice loadings are included in the body of the manual along with anchor and baseplate loads, parts lists, a site layout map, and tower assembly drawings. Critical installation steps are highlighted throughout the manual as shown below.

### SAFETY CONSIDERATIONS:

Failure to follow critical installation steps precisely may result in catastrophic failure of the ginpole or tower and endanger the lives of crew members.

### RECOMMENDATION:

It is recommended that you record a video of the tower lift as an educational tool for future tower lifts as well as helping to continuously improve future tower installations.

## 2.7 TOOLS

### 2.7.1 TOOLS SUPPLIED WITH TOWER KITS

- Metal rust-prevention compound (such as Sanchem, Inc. NO-OX-ID "A-SPECIAL")



## 2.7.2 Tools Supplied with Installation Toolkit #4832

- Klein Tools, Inc. Chicago Grip (PN 1659-20) (3)
- Lug-All Come-Along (Model 115-R) (3)
- Loos & Co. Inc. Model PT-3 Tension Gauge (1)

## 2.7.3 Tools Required but not Supplied

- ¼ inch nut driver (for sensor installation)
- 5/16 inch nut driver (for hose clamps)
- Torque wrenches for wire rope clips (see Table 2-1)
- Torque wrench capable of applying 150 ft-lbs of torque (to tighten 5/8"-11 tower tube joint nuts)
- Small adjustable wrench (for opening/closing acorn clamps)
- Small pliers (for sensor cotter pins)
- Small Phillips head (+) screwdriver (for set screws)
- Flat (-) screwdriver (for antenna mounting assembly)
- Wood blocks (for tube layout and seating tower joints)
- Mallet (for seating tower joints and installing ground rods)
- Large adjustable wrench (for large bolts)
- Hand sledge (for ground rods)
- Level, preferably with a magnetic base (to straighten the tower)
- Compass (for aligning direction sensors)
- Permanent marker (for labeling lower ends of cables)
- Anti-Seize
- Hand grinder (for preparing tube surface for lightning spike)
- Gloves
- Wire cutters/Diagonal cutters
- 2-way radios (at least 4)
- Electric drill with 5/16 inch bit (for unpacking EnviroCrate)
- 9/16 inch wrench, socket or open-end (for base plate assembly and unpacking EnviroCrate)
- Band cutters (for unpacking EnviroCrate)
- 10 ft (3 m) stepladder (for reaching top of helper ginpole)
- Nylon slings (2) with minimum Working Load Limit (WLL) of 6000 lbf (basket hitch)
- (2) Cordless drills with spare batteries to adjust worm gear winches
- 11/16" socket for tightening 5/16" wire rope clips
- ¾" socket for tightening 3/8" wire rope clips and adjusting worm gears
- For use in installing 203 mm (8.0 inch) diameter twin helix anchors (available from Hubbell Power Systems):
  - Locking Dog assembly
  - Drive Wrench



**Table 2-1: Wire Rope Clips, Socket Sizes, and Torque Requirements**

Wire Rope Clip (inches)	Socket Diameter (inches)	Torque Wrench N-m (ft-lbf)
3/16	7/16	10 (7.5)
5/16	11/16	41 (30)

**Table 2-2: Bolt Diameters and Socket Sizes**

Bolt Diameter (inches)	Socket/Wrench Diameter (inches)
3/8	9/16
1/2	3/4
5/8	1-1/16
3/4	1-1/8

## 2.8 UNPACK YOUR TOWER

### 2.8.1 Description of the Envirocrate packaging

NRG has developed the Envirocrate in an effort to reduce packaging waste, protect the tower components and allow for more economical shipment. All of the Super 60 m XHD tower components including anchors and ground kit are included on two pallets. If you purchased this tower as part of an NRG-NOW System, the ginpole, electronics, sensors and associated accessories are packaged separately.

It is very important that you understand how to unpack the contents of the Envirocrate safely. Tower tubes and hardware are heavy and can cause injury if unpacked improperly. The recommended sequence to unpack the tower is described in this section of the manual. Please read this section carefully to avoid serious injury.



**Picture 2-0**





### 2.8.2 Tools required to unpack the Envirocrate

- 5/16 inch nut driver or electric drill with 5/16 inch bit
- 9/16 inch socket and open-end wrench for bolts
- Band cutters
- Gloves
- Safety glasses



**WEAR APPROPRIATE PROTECTIVE GEAR AND USE CAUTION WHEN UNPACKING TALLTOWER COMPONENTS.** WEAR GLOVES AND EYE PROTECTION WHILE UNPACKING THE ENVIROCRATE TO PREVENT CUTS AND OTHER INJURIES FROM BANDS AND SHARP OBJECTS. HEAVY COMPONENTS CAN SHIFT IF NOT UNPACKED CAREFULLY AND IN THE PROPER SEQUENCE. FOLLOW ALL UNPACKING INSTRUCTIONS.



**USE EXTREME CAUTION WHEN UNPACKING HEAVY TALLTOWER COMPONENTS.** LOOSE TALLTOWER COMPONENTS CAN CAUSE SERIOUS CRUSHING INJURIES DURING UNPACKING IF CARE IS NOT TAKEN. ALWAYS FOLLOW UNPACKING INSTRUCTIONS CAREFULLY, AND USE SUFFICIENT INSTALLATION CREW MEMBERS TO REMOVE TALLTOWER COMPONENTS FROM THE ENVIROCRATE PACKAGING IN THE PROPER SEQUENCE.

### 2.8.3 EnviroCrate Access and Orientation

Ideally, you will want access to both ends of the Envirocrates to unpack the contents. If a forklift is available, that is also ideal. Remove the Envirocrates from the truck with the forklift and set them on an unobstructed flat area before unpacking.

It is also possible to unpack the contents with access to only one end of the Envirocrates. For example, the Envirocrate may have been placed into a truck with one end against the front wall of the truck's cargo area and no forklift available to remove the Envirocrate from the truck. In this case, you will be able to follow instructions in this section of the manual to unpack the contents and unload from the truck by hand.

Note: You will NOT be able to unpack the contents of the Envirocrate if the Envirocrate has been loaded into a truck sideways. If the Envirocrate has been loaded into a truck sideways, you will not have the required access to the ends and will need a forklift to remove the Envirocrate.

### 2.8.4 Envirocrate Unpack Sequence – Very Important!

The Super 60 m XHD TallTower ships in two (2) Pallets, Envirocrate Pallet A and Envirocrate Pallet B, as shown in Picture . The sequence for unpacking the Envirocrate A and B is shown graphically in Picture 1-0.1 and 2-0.2, respectively.



# Envirocrate™

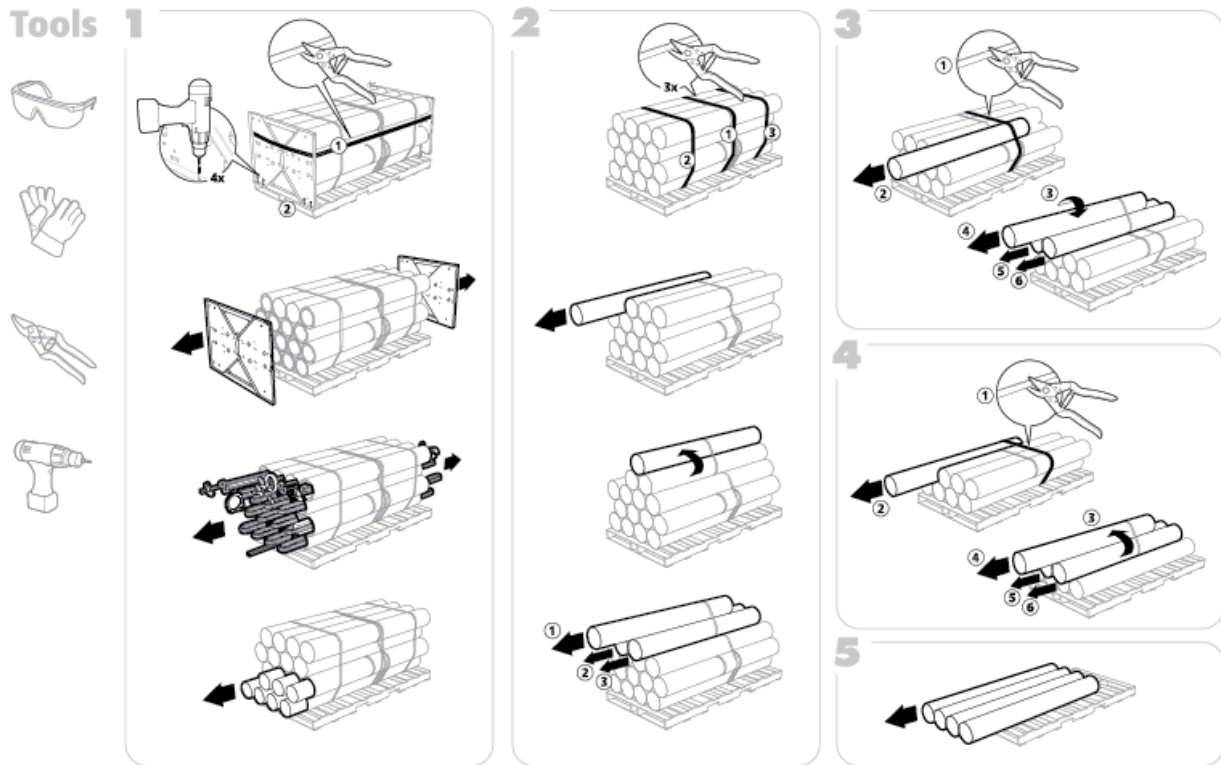

Picture 1-0.1



# Envirocrate™

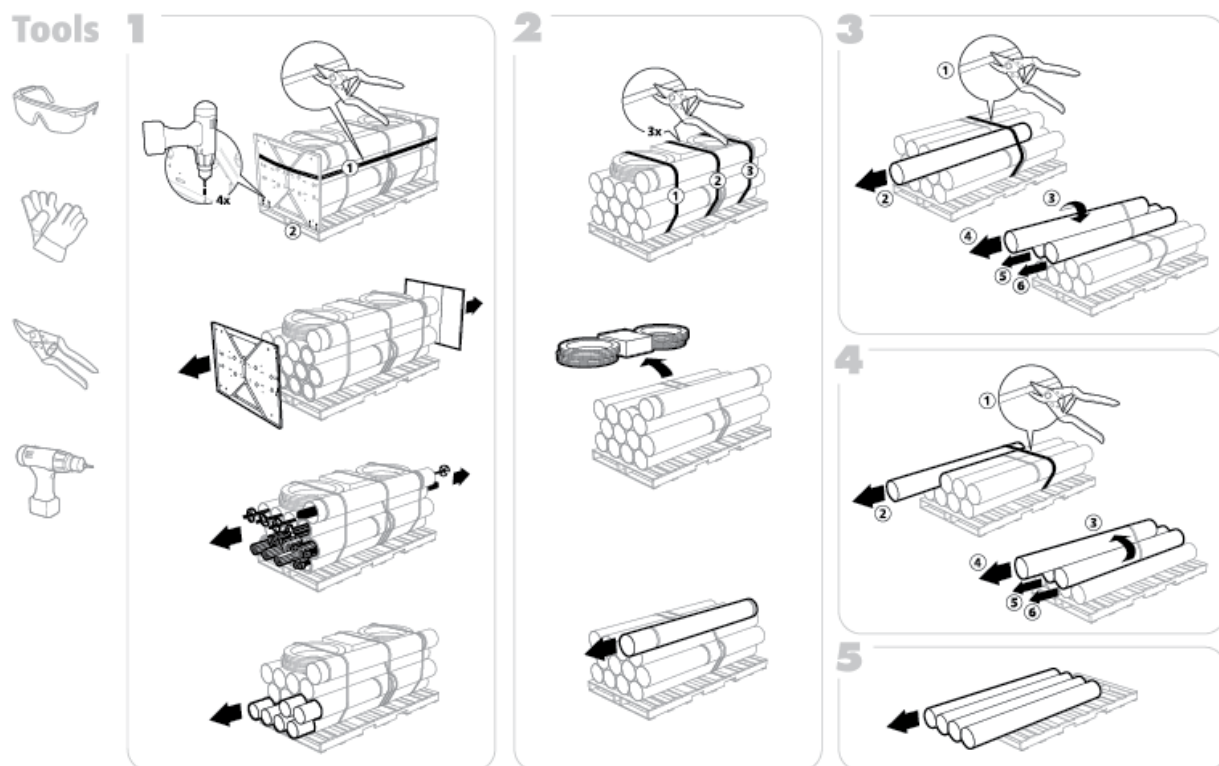

Picture 2-0.2

The general procedure for unpacking the Envirocrate is as follows:

With the banding cutters, cut the single horizontal band (#1) and discard. DO NOT CUT the remaining 5 bands at this time.

With the powered screwdriver, remove the 4 wood screws that fasten each end plate assembly down to the wood pallet.

Set aside the end plate assemblies. If you can only remove one end plate assembly, that is OK – remove the end plate and set it aside. The tube contents will now be exposed.

Remove the contents in the tubes as shown in the picture.

Remove the two (2) 203 mm (8 inch) diameter tubes from the 254 mm (10 inch) diameter tubes, one at a time. Recycle the protective cardboard strips. At this point, there should only be 254 mm (10 inch) diameter tubes remaining on the pallet.

With the band cutters, cut the three (3) bands as shown in picture 2-0.1.



### **Envirocrate A:**

Note that one top layer tube is now free and can be removed. DO NOT CUT the inner 3 bands that are marked with the "DO NOT CUT" tags. These are safety bands that never need to be cut.

The three remaining sections of 254 mm (10 inch) diameter tubing on the top layer are restrained by a small metal safety band (marked with a "DO NOT CUT" tag). These can be safely rearranged without cutting that band by lifting the tube closest to the edge of the EnviroCrate and nesting it on the two other tubes, and the safety band will go slack. Now you may slide this top tube out from underneath the safety band and remove it from the pallet.

Remove the remaining two tubes from the top layer (these two tubes were within the safety band).

With the band cutters, cut another cross-band, and remove the next layer of tubes in the same manner described above. Repeat until the pallet is disassembled.

### **Envirocrate B:**

Remove the transition tube, and guy rings and tower pivot pin (boxed).

Reposition the top 254 mm (10 inch) diameter tube and nest it between two inside tubes. The safety band will go slack. Now you may slide this top tube out from underneath the safety band and remove it from the pallet.

- With the band cutters, cut another cross-band, and remove the next layer of tubes in the same manner described above. Repeat until the pallet is disassembled.

## **2.9 SITE LAYOUT**

### **2.9.1 Pre-installation Planning**

The NRG Super 60m XHD TallTower may require a site permit prior to installation. Check with local building codes or town authorities regarding site permitting.

It is a good idea to visit the site before you order your wind measurement system. You will need to make arrangements regarding how to unload your tower system. Some site preparation may also be necessary.

### **2.9.2 Soil Type and Anchors**

Before ordering your tower, determine the site soil and anchor type required. Per ANSI/TIA-222-G, for design purposes, one can assume Class 6 soils. However, the Standard requires that soil parameters and assumptions be validated prior to installing the tower. It is your responsibility to determine which type of anchor is appropriate for your specific site. Depending on the soil type, anchoring can take varying levels of planning, effort and time. Be sure to know what soil types you are dealing with as part of your pre-installation planning process.

The Super 60 m XHD TallTower anchors require mechanical means to install. In addition, all anchors shall be pull tested to 66.7 kN (15000 lbf) prior to tower erection. The 19.5 ft<sup>2</sup> baseplate is sized to ensure the factored resistance of Clay soil (Class 6) is greater than the reactions from the factored loads per ANSI/TIA-222-G. If actual soil conditions depart from these assumptions, it may be necessary to provide a foundation to ensure adequate bearing strength.



Please refer to the anchoring guidelines in [Appendix B: Anchoring Guidelines](#) and [Appendix H: ANSI/TIA-222-G Foundation Considerations](#) of this manual for more information.



**USE ONLY SUITABLE TOWER ANCHORS FOR THE SOIL TYPE AT THE INSTALLATION SITE.** STABILITY OF THE COMPLETED TOWER UNDER VARYING CONDITIONS (E.G., HIGH WINDS AND ICE), AND STABILITY DURING INSTALLATION, DEPENDS ON THE USE OF PROPER ANCHORS FOR THE SOIL TYPE AT THE INSTALLATION SITE. FAILURE TO USE PROPER ANCHORS COULD CAUSE THE TOWER TO FALL CAUSING SERIOUS INJURY OR DEATH OR PROPERTY DAMAGE. CONSULT WITH THE APPROPRIATE PROFESSIONALS TO FIRST DETERMINE SOIL CONDITIONS AND THEN SELECT THE PROPER ANCHOR SYSTEM BEING SURE TO FOLLOW ALL ANCHOR MANUFACTURER'S INSTRUCTIONS.

**Tip: Cellular Coverage**

This is also a good opportunity to identify what type of cellular service is available at the site for those who will be using an NRG iPack to transmit data. For more information on NRG iPacks, contact NRG.

**2.10 SITE LAYOUT MAP**

The NRG Super 60m XHD TallTower is suitable for installation in flat or rolling terrain with slopes less than or equal to 3° (1:20). Picture 2.1 shows the permissible terrain/slope combinations. Do not install this tower on slopes greater than 3° (1:20) or in sites where it is greater than 3° down from the baseplate to both the tower *and* the winch anchor.



**INSTALLING TOWERS ON SLOPED TERRAIN CAN CAUSE EXCESSIVE GUY WIRE LOADS AND INSTABILITY DURING INSTALLATION. DO NOT INSTALL TALL TOWERS ON SLOPES GREATER THAN 3° (1:20) AS INSTABILITY CAN RESULT CAUSING SERIOUS INJURY OR DEATH. CAREFULLY READ AND FOLLOW ALL APPLICABLE INSTRUCTIONS ON INSTALLATIONS WHERE A SLOPE OF LESS THAN 3° IS PRESENT.**

### 2.10.1 Slopes Greater than +1.5°

For slopes greater than +1.5° up from the baseplate-to-ginpole, the ginpole jumper struts will likely contact the ground before the tower reaches vertical. In this case, you will need to do one or all of the following:

Proceed with the tower raising as you normally would following the instructions in this Manual. When the tower is near vertical and the lower jumper struts are nearing ground contact, de-tension all four (4) jumper strut wires by loosening each of the four (4) turnbuckles. After de-tensioning the jumper strut wires, remove one of the two jumper strut mounting bolts (from the bottom jumper struts) and swing the lower jumper struts out-of-the-way. Proceed with the tower raising.

Proceed with the tower raising as you normally would following the instructions in this Manual. When the tower is near vertical and the lower jumper struts are nearing ground contact, STOP the tower raising. The tower will be near-vertical but not at 90°. Attach the front guys to their respective anchors (see 4.4 Attaching Front Guy for more detail). Follow the procedures outlined in 4.5 Plumb and Straighten Tower to plumb the tower. Anticipate it taking longer to plumb the tower since the tower has to physically move a greater distance.

Perform site work before assembling the ginpole. Using an excavator or other suitable device, dig a hole 0.3 m (1 ft) in depth, approximately 9.4 m (31 ft) from the tower baseplate (in the direction of the final ginpole position) so that the ginpole jumper strut tips will not contact the ground but be below grade when the tower is vertical.

### 2.10.2 Slopes Less than -2°

For slopes less than -2° down from the baseplate-to-ginpole, the height from the ground to the top of the ginpole (when the tower is vertical) will exceed 8 feet. In this case, NRG recommends using a 12 foot step ladder to access the top of the ginpole to remove the lifters for storage. Alternatively, one could use scaffolding to access the top of the ginpole if the site permits its transport and you are willing take the necessary steps to set it up.

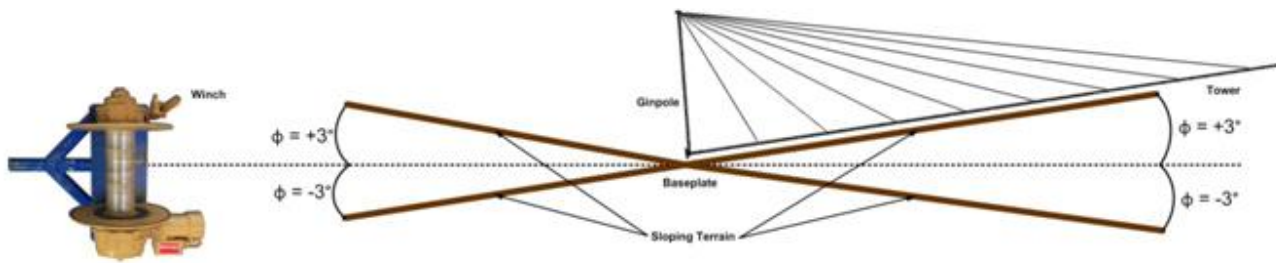

Picture 2.1



Lay out the site so that the tower is laid out downwind of the baseplate, to ensure that the tower will be lifted into the wind.



**ALWAYS LIFT TALLTOWERS INTO THE WIND. LIFTING TALLTOWERS WITH THE WIND CAN CAUSE WIND TO PUSH THE TOWER OVER OR MAKE LIFTING FORCES UNPREDICTABLE, AND COULD RESULT IN SERIOUS INJURY OR DEATH. ALWAYS LAY OUT THE TOWER SO IT IS DOWNWIND OF THE BASEPLATE; THIS WAY YOU WILL BE LIFTING THE TOWER AGAINST THE WIND.**

**NOTE:** When laying out a TallTower installation on a slope, measure the calculated distances along the ground to place the anchors. It is not necessary to compensate for the slope. TallTower guy wires are long enough to allow for installation on slopes up to 3° while maintaining the ideal angle between the tower and the guys.

Measure carefully to place the anchor points, paying extra attention to the placement of the winch anchors. Verify that the anchor radii and the diagonal distances between anchors are correct (reference Picture 2.2 for Site Layout Map).

Picture 2-3 shows a magnified plan-view of the tower baseplate and tower showing the placement of two (2) 8-inch diameter single helix anchors. One of these 8-inch diameter single helix anchor is used to secure the tower baseplate; the other is used for storing the lifters.

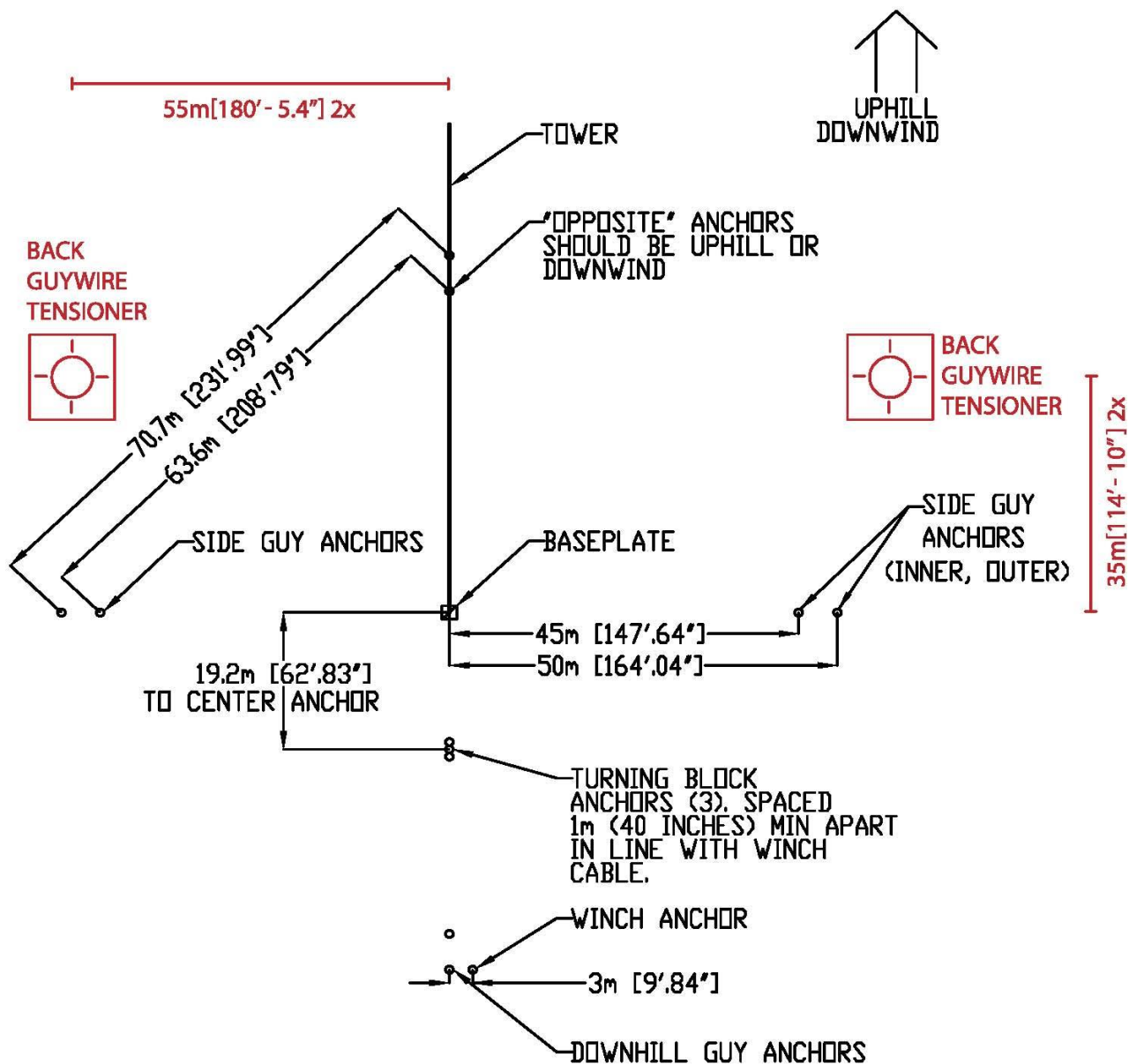

## SUPER 60m XHD TALLTOWER SITE LAYOUT

Picture 2.2: Super 60 m XHD Site Layout Map (plan view)



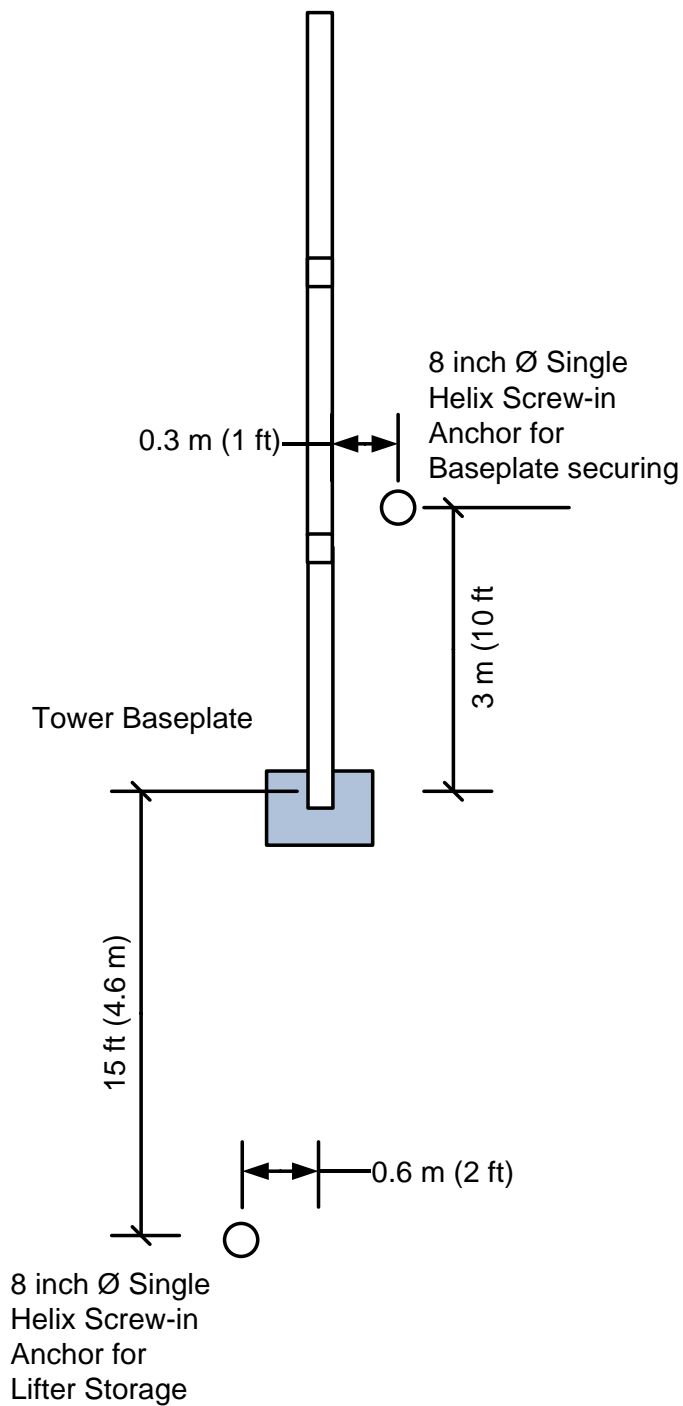

- 8 inch Ø Twin
- Helix Turning
- Block Anchors

**Picture 2-3: Placement of 8 inch Single Helix Screw-in Anchors (2)**

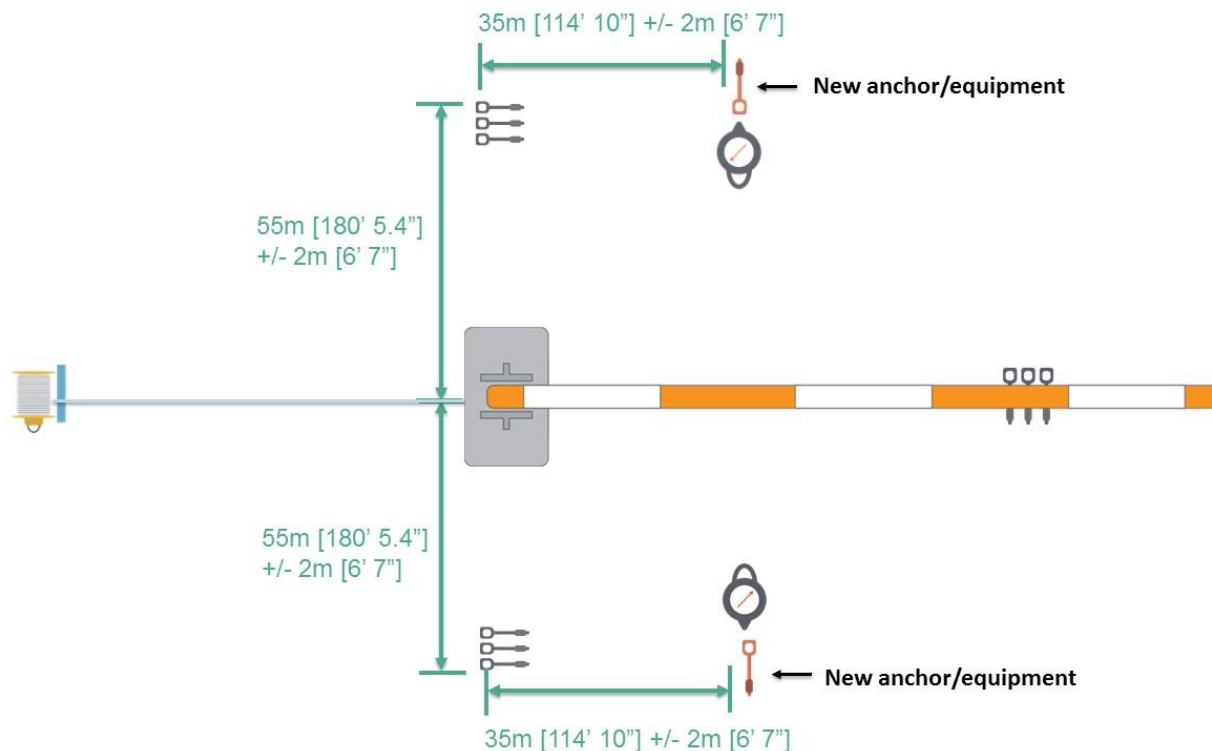

**Picture 2-4: Layout drawing showing location of back stay tensioning system**

**NOTE:** The side guy anchors and the base plate should be on a straight line. If it is not possible to place them in the locations shown, it is better to move them in or out along the line to the baseplate than to move them off the line. Do not move them more than 1.5 m (5 feet) off the line.

**NOTE:** Extra care will have to be taken while raising the tower if:

- Anchor placement is not perpendicular to the tower as it lays on the ground.
- Anchors are not at the same elevation.
- Side anchors and base plate are not in a straight line.

**NOTE:** Any of these conditions will affect the side guy wire tension and the ginpole safety wire rope tension as the tower is raised. Tension will have to be continuously monitored and periodically adjusted as the tower is lifted.

Placement of the winch anchors is critical. Make sure that you measure carefully and set the anchor heads 6 inches above ground level. Angle all three anchors towards the tower at 45 degrees.

All of these factors are important for proper distribution of forces and for clearance and proper operation of the ginpole.

Lay out the disassembled tube sections on the ground according to sequence described, beginning at the baseplate. Pay close attention to the location of the guy rings, the transition tube, and the color of the tubes (for painted towers). Refer also to the Tower Layout drawing located in [Appendix A: Super 60m XHD with Standard Footprint](#) and the painted tower drawing located in [Appendix I: Super 60m TallTower Painted Version](#).



## 2.11 CONNECT THE CURTIS BRIDLE ASSEMBLY TO THE 3 BLOCK PULLEY ANCHORS

The NRG Systems supplied Bridle kit (NRG Kit # 18046) consists of the following equipment:

- (3) 5/8" Shackles
- (2) Ten foot lengths of 3/8" wire rope
- (4) 3/8" Thimbles
- (2) 3/8" Sleeves (already swaged)
- (4) 3/8" Wire rope clips

Two lengths of wire rope will connect the three block pulley anchors together, to minimize deflection during the tower raise.

- Thread the swaged end of the (1) wire rope length onto a shackle, then connect it to the first anchor rod below the triple eye head.
- Thread the swaged end of the (1) wire rope length onto a shackle, plus (1) loose thimble, then connect it to the middle anchor rod, below the triple eye head.
- Thread the remaining loose thimble onto the last shackle and connect it to the remaining anchor rod, below the triple eye head.
- Stretch the end of the cable through the loose thimble and shackle and tighten back to itself, securing with (2) wire rope clips.
- Repeat the process for the second length of wire rope.

Your setup should resemble the drawing below:

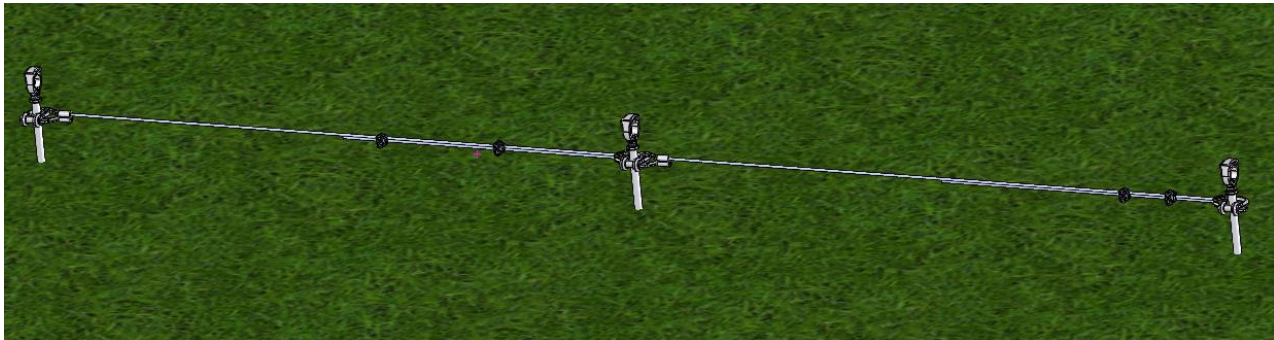



## Chapter 3: Tower Components Assembly

### 3.1 ASSEMBLE THE BASEPLATE

The baseplate will be located according to the site layout map described in the Site Layout Map section. It is often easiest to assemble the baseplate on-site where the tower will be installed. Assemble 4 of the 6 large triangular baseplate sections as shown in picture 3-1 below.

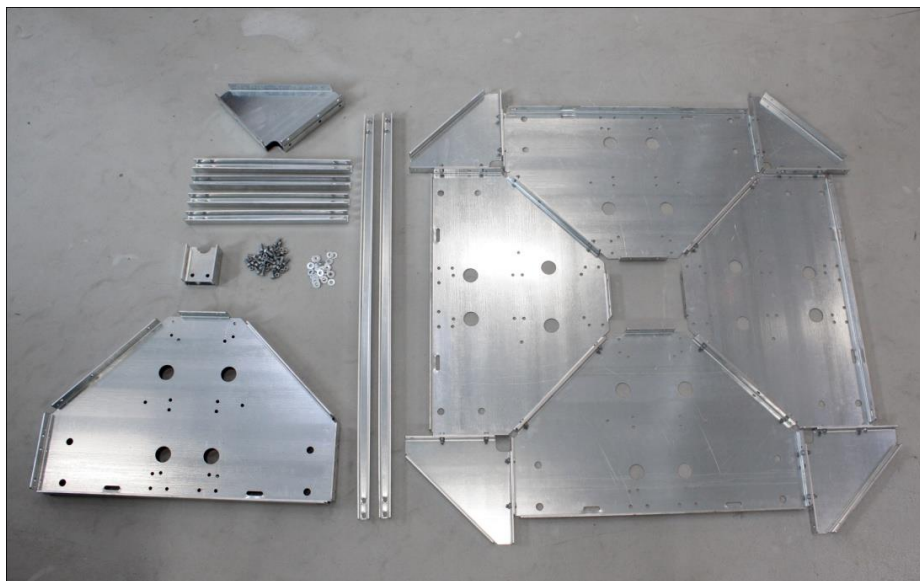

**Picture 3-1: Baseplate Parts**

Insert eight (8) 3/8"-16X1" bolts in the outer holes of each mating flange. Leave nuts somewhat loose; tighten by hand only.



**Picture 3-2: Baseplate Assembly**



Bolt the corner pieces to the triangular baseplate section using sixteen (16) 3/8"-16X1" bolts, as shown in Picture 3-2. Tighten all nuts using a 9/16" socket or open-end wrench.



**Picture 3-3: Baseplate Assembly**

While the baseplate is upside down, attach the six (6) stiffeners as shown in Picture 3-4. Note two (2) of the stiffeners are long and extend the full dimension of the baseplate. The other four (4) stiffeners are short and extend from the edge of the baseplate to the center square hole. Use washers under the 3/8"-16 nuts of the slotted holes in the channels.

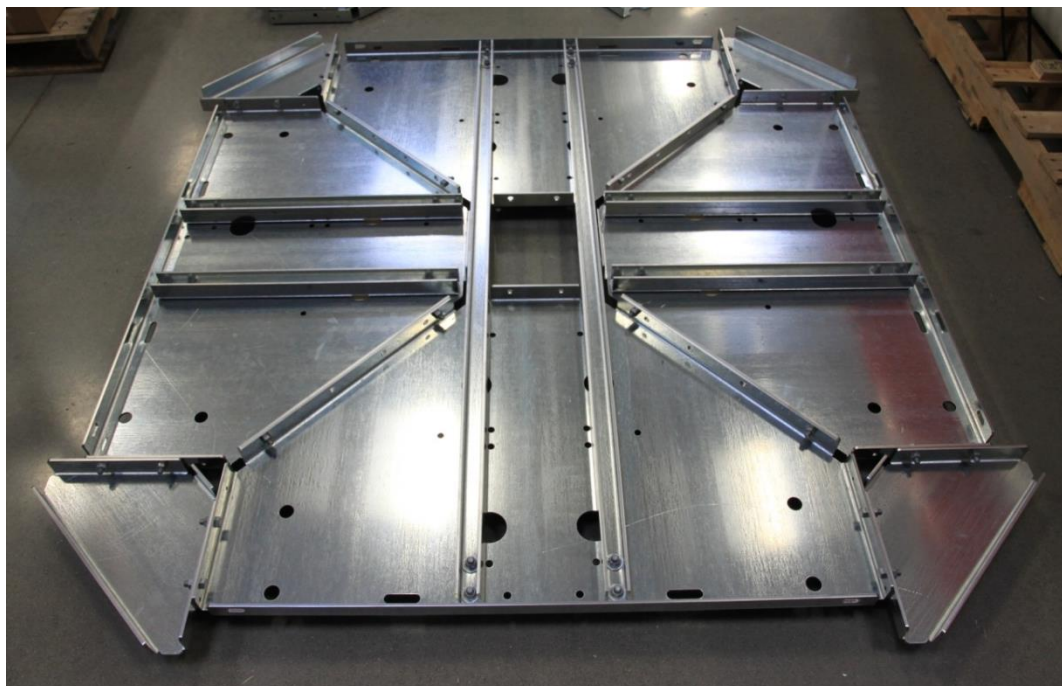

**Picture 3-4: Baseplate Assembly**



Flip over the baseplate assembly, and prop up on one edge to allow access to underside of baseplate. Attach the vertical uprights to the center of the baseplate as shown in picture 3-5 below, with flanges facing outward, and with the vertical pieces perpendicular to the two (2) long stiffeners (visible through center hole). Use washers under the nuts to cover the slotted holes.

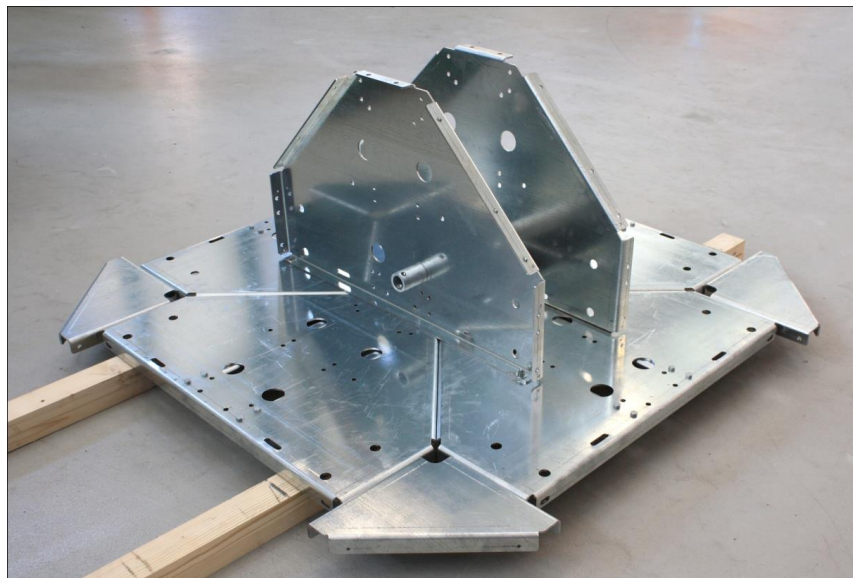

**Picture 3-5: Baseplate Assembly**

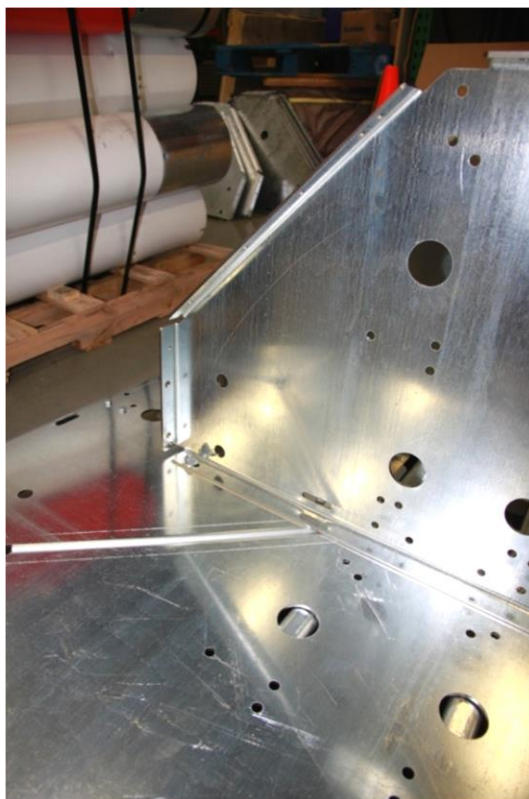

**Picture 3-6: Baseplate Assembly**

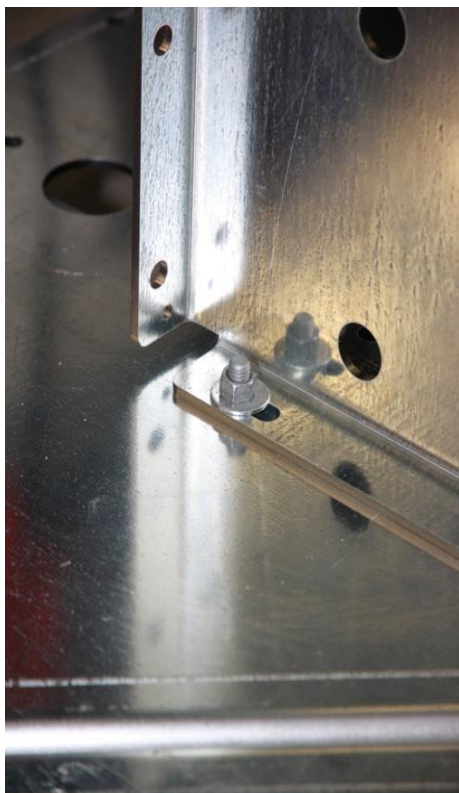

**Picture 3-7: Baseplate Assembly**

Install gussets directly across from each other, attaching them perpendicular to the vertical uprights as shown in picture 3-8 below. Be sure to install the gusset bolts with the nuts toward the gusset. Tighten all bolts in the baseplate.

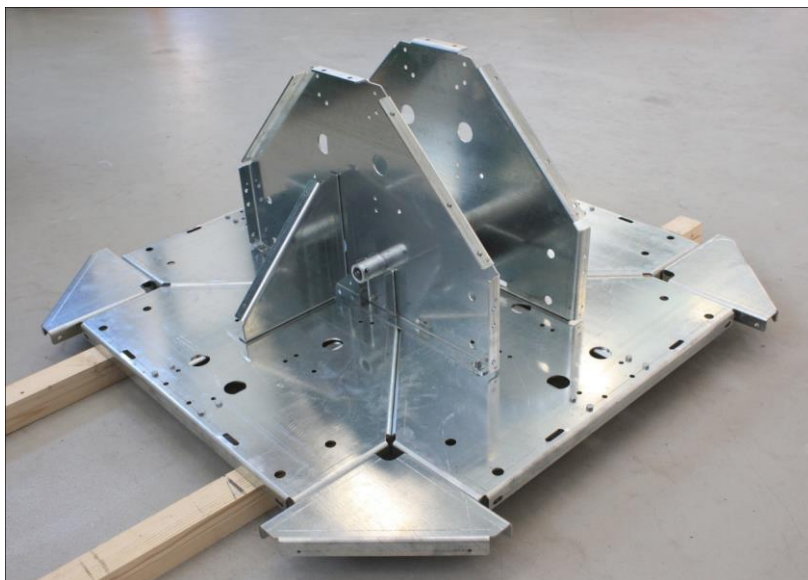

**Picture 3-8: Baseplate Assembly**

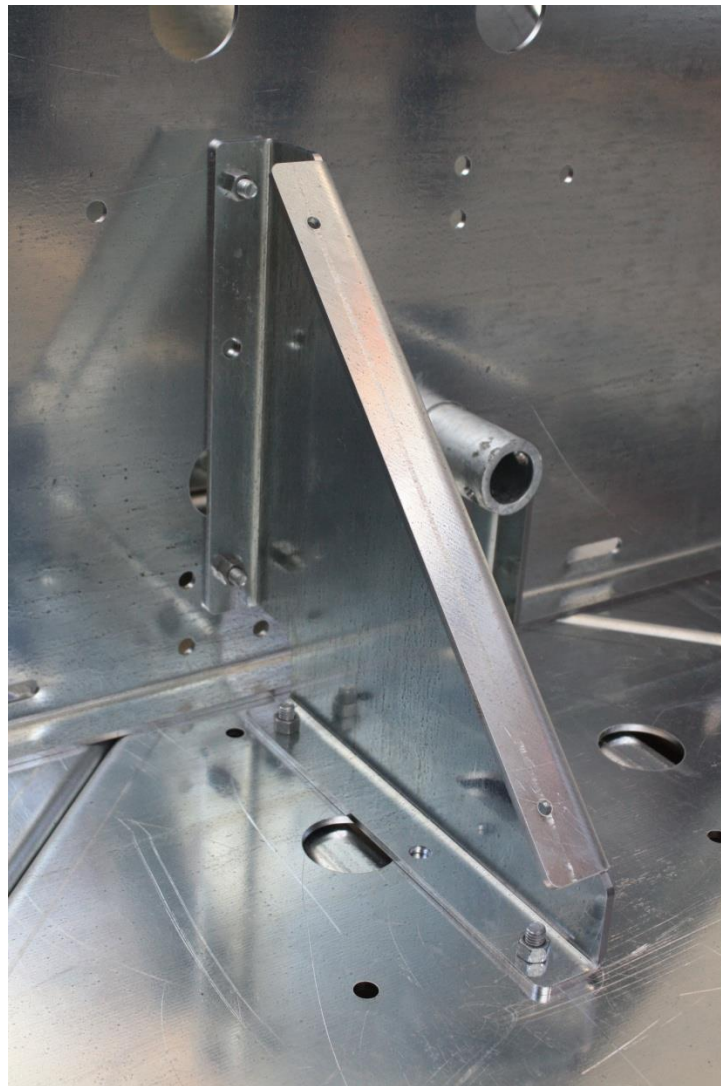

**Picture 3-9: Baseplate Assembly**

Install the doublers on the vertical pieces as shown in picture 3-10 below. Carefully align the “saddle” cutouts with the large holes in the vertical pieces so that the pivot tube can pass through (inserting the pivot pipe as shown in the photo will aid in the correct placement of the doublers). Make sure the bolt and nut are oriented as shown, nut on the outside.



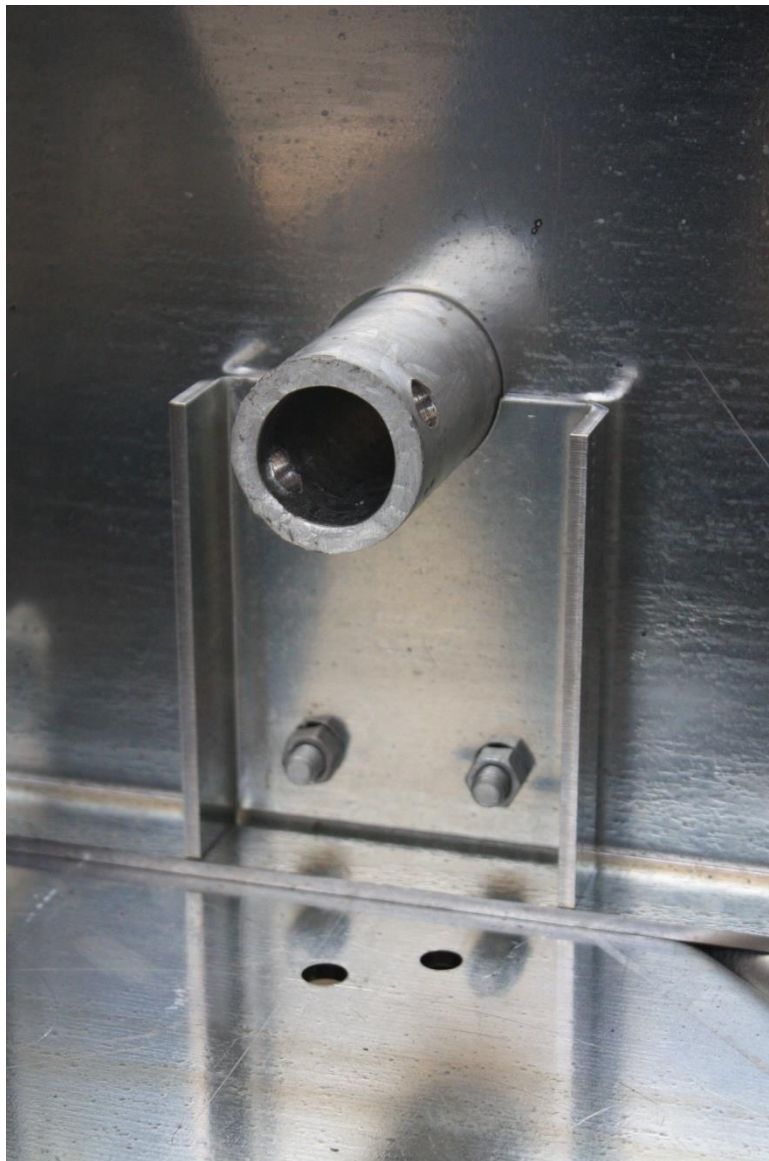

**Picture 3-10: Baseplate Assembly**

Place the baseplate at the installation site, orienting it with the gussets closer to the winch.

At the beginning of a lift, the forces acting on the baseplate are predominantly horizontal. These forces tend to slide the baseplate toward the winch and/or tip the baseplate up on edge. To counteract these forces, the baseplate must be anchored using the set-up described in the section entitled *3.2 Assemble Cable from Baseplate to 8" Screw-in Anchor*.



### 3.2 ASSEMBLE CABLE FROM BASEPLATE TO 8" SCREW-IN ANCHOR

A bridle cable and short-run of wire rope (assembly supplied with the tower) are used to secure the baseplate. The bridle straddles the tower tube pivot pipe, as shown in the picture below. Secure the bare-end of the short-run of wire rope (attached to the bridle) to the 8" screw-in anchor. The 8" screw-in anchor is installed in close proximity to the baseplate (for details on anchoring, see the section entitled 2.10 Site Layout Map).

Thread the bare-end of the wire rope through the triple-eye of the 8" anchor. Make sure the cable assembly is tight (no sag) using a come-along and Chicago Grip to assist. Secure the bare-end wire rope using three (3) 5/16" wire rope clips.

Drive ground rods through the baseplate holes to provide a grounding pathway for the tower and additional anchoring for the baseplate. Affix a 5/8" acorn clamp to each of the ground rods. Clamp one end of the bare 8-gauge copper wire to the acorn clamp and the other end to the tower, affixed to a ground lug and screwed into the baseplate.

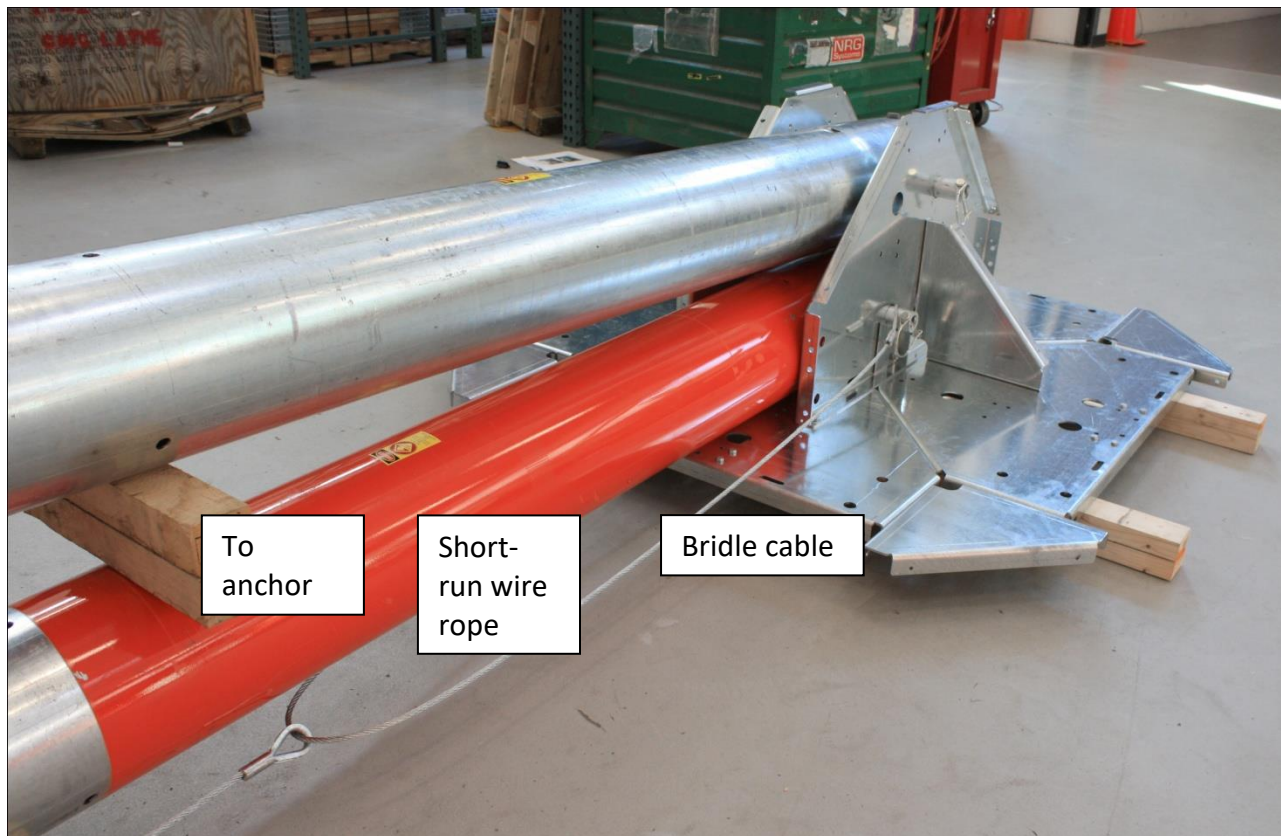

**Picture 3-11: Baseplate Bridle Assembly**



Picture 3-12: Ground Rod Placement

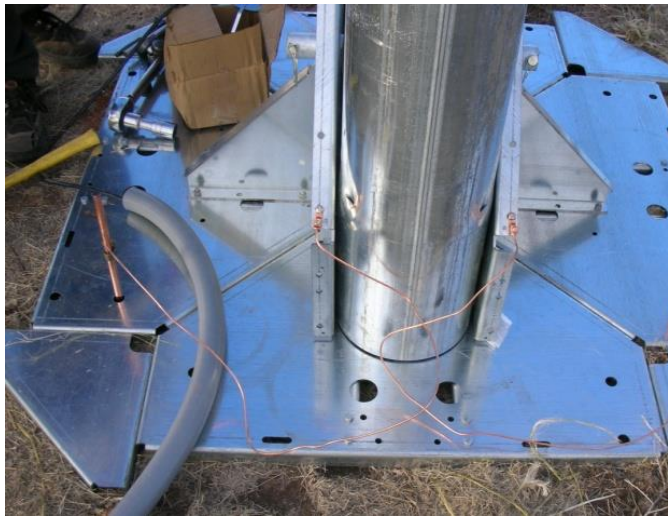

Picture 3-13: Tower Grounding

### 3.3 INSTALL THE ANCHORS

See [Appendix B: Anchoring Guidelines](#) for more information on installing anchors. Depending on the soil type, anchoring can take varying levels of planning, effort and time. Be sure to know what soil types you are dealing with as part of your pre-installation planning process.

Leave the eye of all anchors approximately 150 mm (6 inches) above ground. This leaves plenty of room to add a shackle that aids in attaching your Lug-All Come-Along when adjusting guy wire tension.



**USE ONLY SUITABLE TOWER ANCHORS FOR THE SOIL TYPE AT THE INSTALLATION SITE.** STABILITY OF THE COMPLETED TOWER UNDER VARYING CONDITIONS (E.G., HIGH WINDS AND ICE), AND STABILITY DURING INSTALLATION, DEPENDS ON THE USE OF PROPER ANCHORS FOR THE SOIL TYPE AT THE INSTALLATION SITE. FAILURE TO USE PROPER ANCHORS COULD CAUSE THE TOWER TO FALL CAUSING SERIOUS INJURY OR DEATH OR PROPERTY DAMAGE. CONSULT WITH THE APPROPRIATE PROFESSIONALS TO FIRST DETERMINE SOIL CONDITIONS AND THEN SELECT THE PROPER ANCHOR SYSTEM BEING SURE TO FOLLOW ALL ANCHOR MANUFACTURER'S INSTRUCTIONS.

### 3.4 TUBE LAYOUT

Lay out the disassembled tube sections on the ground according to sequence described in Table 3-1 & 3-2, beginning at the baseplate. Pay close attention to the location of the guy rings, the transition tube, and the color of the tubes (for painted towers). Refer also to the Tower Layout drawing located in Appendix A: [Super 60 m XHD TallTower with Standard Footprint](#) and the painted tower drawing located in [Appendix D: Super 60 m XHD TallTower Painted Version](#).



**Table 3-1: Tube Layout (SI Units)**

**Sequence of tubes in each section:**

**A guy ring is placed over the first tube listed in each section (except Section 1)**

Section 1	Section 2	Section 3	Section 4	Section 5	Section 6	Section 7
Base Tube + (4) 2.2 m, 254 mm Ø Tubes	(5) 2.2 m, 254 mm Ø Tubes	(5) 2.2 m, 254 mm Ø Tubes	(5) 2.2 m, 254 mm Ø Tubes	(5) 2.2 m, 254 mm Ø Tubes	(4) 2.2 m, 254 mm Ø Tubes + (1) Transition Tube + (1) 2.2 m 203 mm Ø Tube	(1) 2.2 m, 203 mm Ø Tube
No guy ring on this section.	Guys attached to this guy ring are color coded:  Red	Guys attached to this guy ring are color coded:  White	Guys attached to this guy ring are color coded:  Black	Guys attached to this guy ring are color coded:  Yellow	Guys attached to this guy ring are color coded:  Blue	Guys attached to this guy ring are color coded:  Green



**Table 3-2: Tube Layout (Imperial Units)**

**Sequence of tubes in each section:**

**A guy ring is placed over the first tube listed in each section (except Section 1)**

Section 1	Section 2	Section 3	Section 4	Section 5	Section 6	Section 7
Base Tube + (4) 87 inch, 10 inch Ø Tubes	(5) 87 inch, 10 inch Ø Tubes	(5) 87 inch, 10 inch Ø Tubes	(5) 87 inch, 10 inch Ø Tubes	(5) 87 inch, 10 inch Ø Tubes	(4) 87 inch, 10 inch Ø Tubes + (1) Transition Tube + (1) 87 inch, 8 inch Ø Tube	(1) 87 inch, 8 inch Ø Tube
No guy ring on this section.	Guys attached to this guy ring are color coded:  Red	Guys attached to this guy ring are color coded:  White	Guys attached to this guy ring are color coded:  Black	Guys attached to this guy ring are color coded:  Yellow	Guys attached to this guy ring are color coded:  Blue	Guys attached to this guy ring are color coded:  Green

### 3.5 INSTALL THE TOWER BASE TUBE

Identify the tower base tube. The base tube has a 51 mm (2 inch) diameter hole drilled through the flared (wider) end. It also includes an insert in the flared portion of the tube, as shown in picture 3-14 below.

**NOTE:** Both the tower and ginpole base tubes possess a 51 mm (2 inch) diameter hole drilled through the flared end. However, the tower base tube is painted orange whereas the ginpole base tube is not painted.

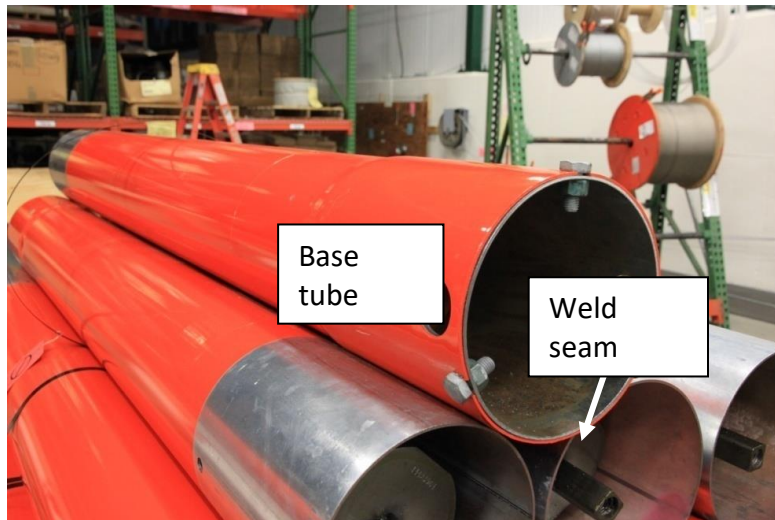

**Picture 3-14: Base tube insert**

Attach the base tube to the baseplate using the pivot pipe through the lower holes in the center of the baseplate sides. Make sure the weld seam of all tubes points down, as shown in picture 3-14 above. Make sure the base tube is pointed in the direction intended for tower assembly and subsequent tilt-up (see 2.9 Site Layout for more details on tower layout). Secure the pivot pipe using a quick release pin at each tube end.

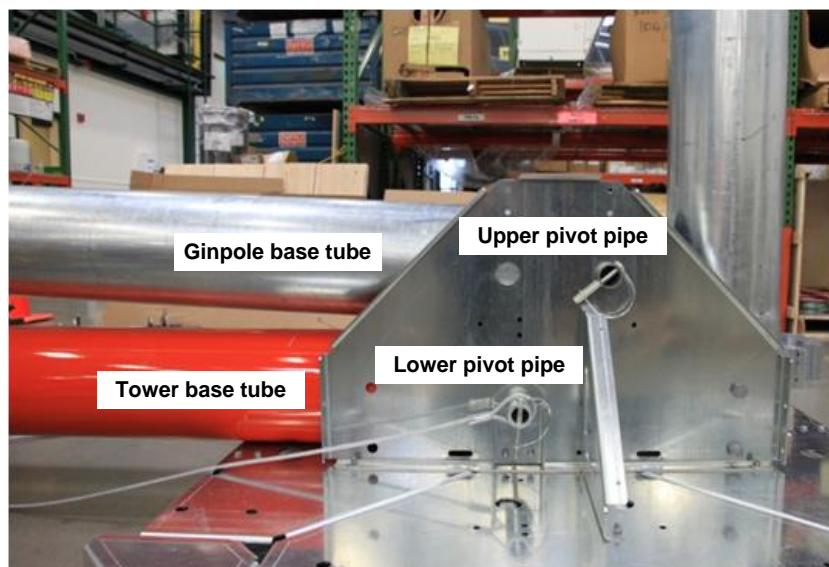

**Picture 3-15: Baseplate fully assembled/ready for lifting**



Insert 5/8"-11X1-1/2" bolts through the holes in the un-flared tube end. Place a 5/8" inner diameter washer and a 5/8"-11 nut loosely on each bolt. Make sure the bolts are inserted from the inside of the tube (nuts are on the outside of the tube), as shown in the pictures below. Line up the mating slots in the flared end of the mating tube with the bolts in the un-flared tube – one bolt is aligned vertically and the remaining two bolts point downward.



**Picture 3-16: Attach tower bolt/nuts**



**Picture 3-17: Tubes ready to be connected, weld seam down**



Slide tube sections together, as shown in picture 3-18.



**Picture 3-18: Sliding together tube sections**

As the flared end nears the bolts, pick up top bolt and washer so that the slot can mate with the bolt shank. Continue to slide the mating tubes together until the slots bottom out against the bolts.

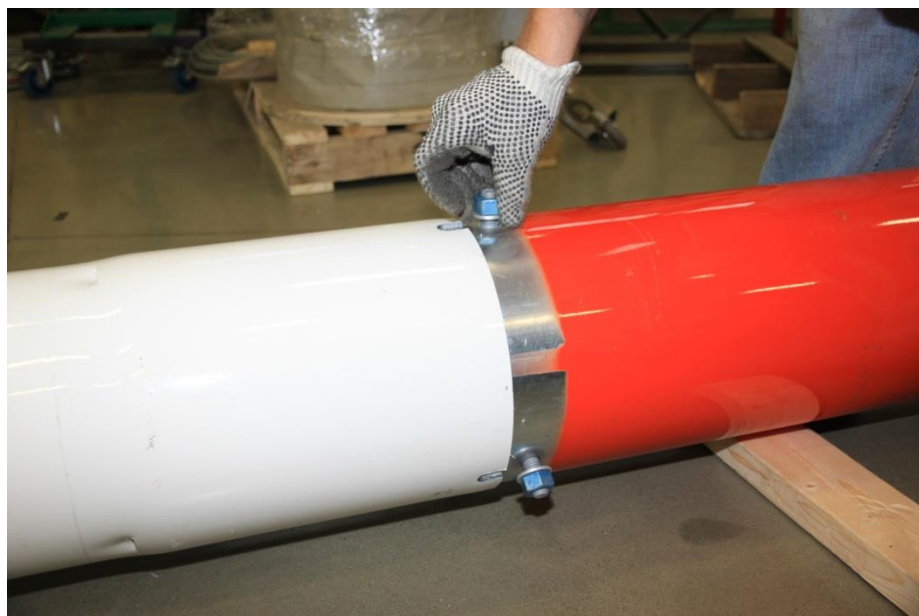

**Picture 3-19: Top bolt must be held when tubes slide together**





Hand tighten the nuts.



**Picture 3-20: Nuts/bolts hand tightened**

Place a wood block against the unflared end of the mating tube, as shown in picture 3-21 below. Using a mallet, hammer the wood block several times using a firm blow. Verify the end of the mating tube is less than 3.2 mm (1/8 inch) from each of the three (3) the lances. If the gap between the tube and any of the lances exceed 3.2 mm (1/8 inch), apply additional blows to the wooden block using the mallet until the tube is fully seated.



**Picture 3-21: Seating the tubes with a mallet**

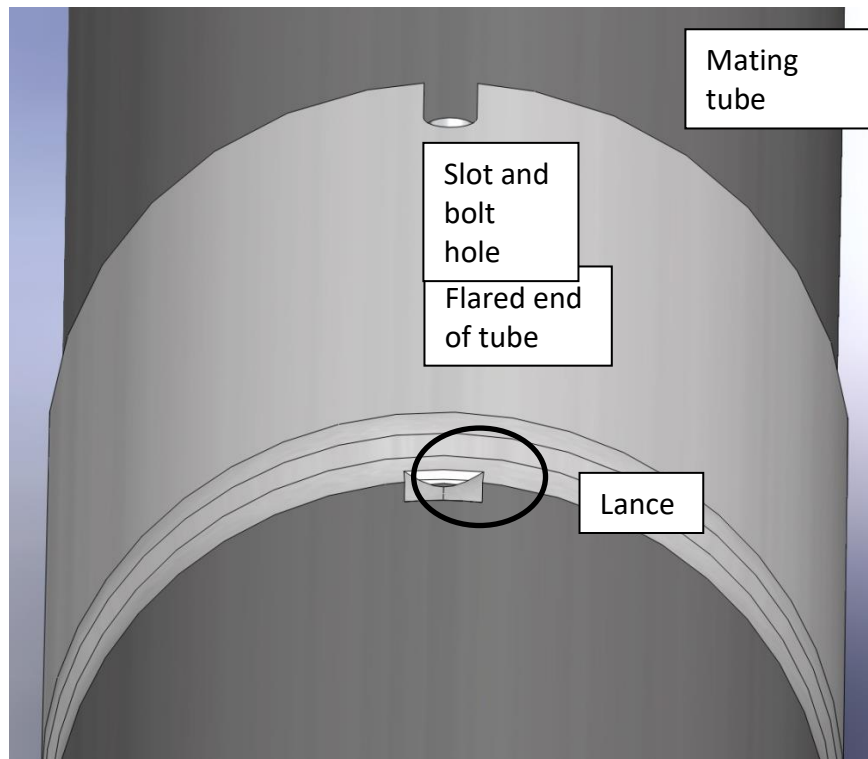

**Picture 3-22: Tube lance and slot**

A simple tool/jig can be made with a mark at 1/8" that can be inserted into the lance until it bottoms out on the inside tube. If your mark lines up on all 3 lance holes, proceed to torque the 2 tubes together.

Do not assemble the entire tower before torqueing each joint-torque each tube joint as you go.

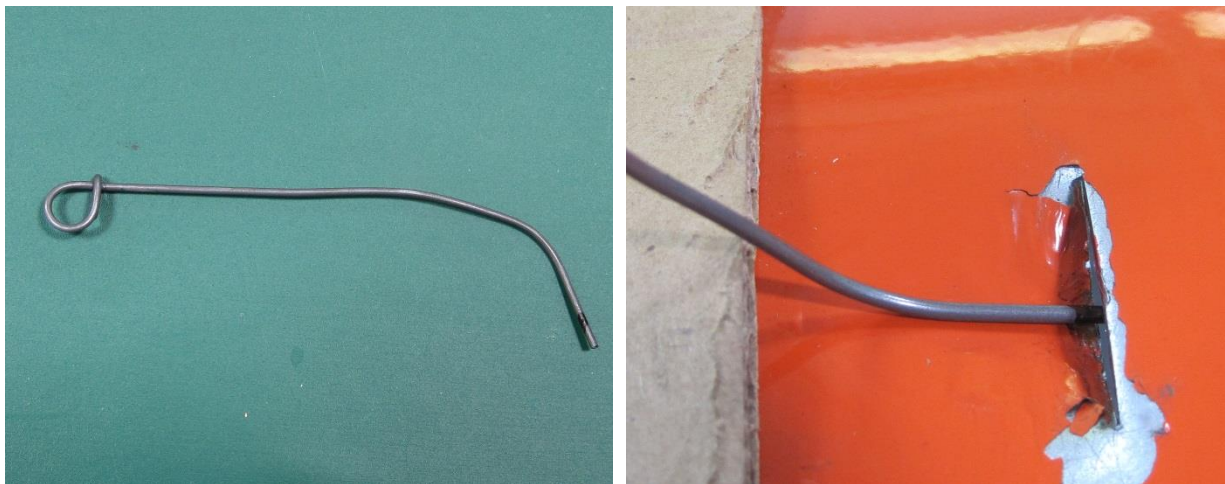

**Picture 3-23: Example of tool that can be used to confirm tubes are mated together fully**



**Picture 3-24: Torquing the nuts**

Using a torque wrench and 1-1/16" socket, torque the 5/8"-11 nuts to 203 Nm (150 ft-lbs).



**Picture 3-25: Tube joint fully torqued with palnut attached**



To provide anti-rotation to the bolt-nut assembly, screw on 5/8"-11 Palnuts on top of each 5/8"-11 nuts-shown in picture 3-25 above.

Best practice is to fully seat the tubes together, double check through the lance that the joint is correct. Torque the nuts to 203 Nm (150 ft-lbs), then attach Palnuts. The Palnuts are then a visual to remind you that the tube joint is correct and the nuts have been torqued.

**Continue to assemble the tubes in the manner described above and place guy rings over the tubes according to the sequence outlined in Tables 3-1 and 3-2.**

Make sure the guy ring is placed so the guy ring corners are bent towards the baseplate and in line with each anchor point. Place wood blocks every 5 to 6 meters (15–20 feet) to support the tower above the ground, keeping the tower perfectly straight.



**Important:** If the tower site is not flat, supports will need to be constructed so the tower can be built in a straight line and level.

### 3.6 ATTACH THE LIGHTNING SPIKE

#### **NOTICE**

The lightning spike is not used in the goal post boom configuration.

Attach the lightning spike to the top tower tube using the three (3) hose clamps provided. To prevent the lightning spike from rotating, insert the ¼-14X1.25" self-drilling screw into the clearance hole, near the base of the rod, and drive the screw into the tower tube using an electric drill and 3/8" bit as shown in the picture below.

If you are using a Flash Technology L-864 beacon light as part of your obstruction marking system, the lightning spike must stick up above the light a minimum of 0.9 m (36 inches) to satisfy required clearance distances. In addition, for the Flash Technology L-864 beacon, there must be a minimum of 0.45 m (18 inches) of clearance between the lightning spike and the mounting plate or beacon housing as shown in the picture below.

Clearance distances between the lighting system and lightning rod are make and model dependent. Check with the manufacturer of the lighting system you are using to verify the required clearances. Adjust or modify the lightning spike accordingly.



You will need to prepare the surface of the top tower tube by removing the orange paint directly beneath the lightning spike. Use a grinder or other suitable device to remove the paint from the tube to ensure the lightning spike will be in direct contact with bare metal (see picture below). Once the paint is removed, apply a liberal layer of rust-prevention coating (such as Sanchem, Inc. NO-OX-ID "A-SPECIAL") to ensure a long-term bond between the lightning rod and metal tube.

Your lightning spike installation should look similar to the set-up shown in picture 3-26 below.

**NOTE:** Analysis and testing conducted by NRG Systems verified the copper down-tower conductor is not necessary for lightning protection of the tower and instruments. The copper down-tower conductor is not included in the lightning kit.

For more details on lightning protection, contact NRG Systems.

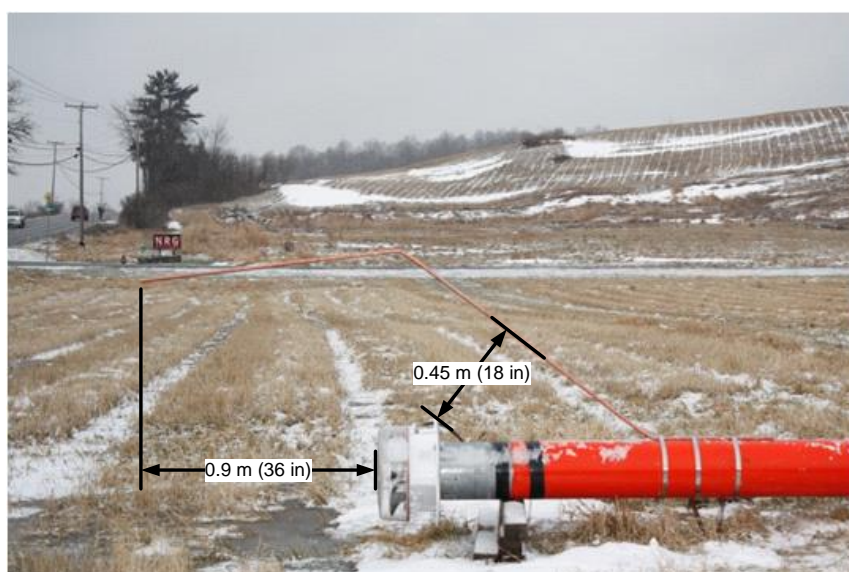

**Picture 3-26: Lightning spike and beacon light fully assembled**

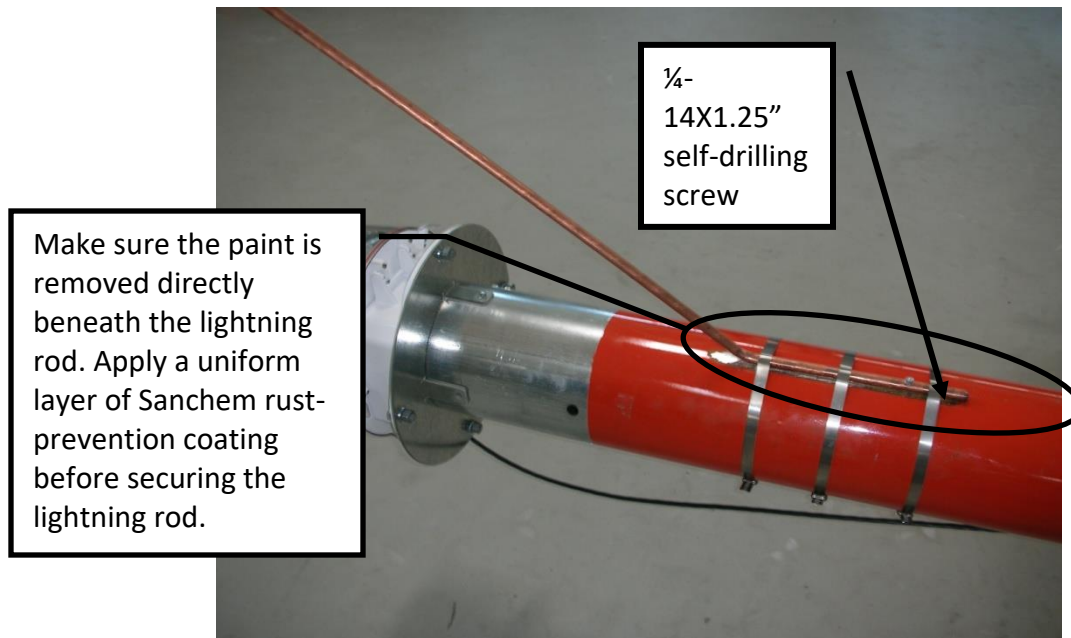

**Picture 3-27: Proper lightning spike installation**

### 3.7 ATTACH SENSORS AND BOOMS

Assemble the sensors, sensor boots, and sensor signal cables to the booms. Wrap the sensor signal cables to the boom. Secure with weather rated electrical tape such as Scotch Super 88. Secure the booms to the tower with the supplied hose clamps.



**Picture 3-28: Boom installation**



If you purchased the sensors and booms as part of a NRG-NOW System, cabling was supplied for (1) 60 m level direction vane, (2) 60 m level anemometers, (1) 50 m level direction vane, (2) 50 m level anemometers, and (2) 40 m level anemometers. It is always easiest to run the cables from the sensor and booms down the tower. Refer to **Error! Reference source not found.** for wind vane alignment tips.

### 3.8 SPIRAL WRAP YOUR SENSOR CABLES

Spiral-wrap the sensor cables around the tower, completing one wrap per tube joint. The spiral-wrap destabilizes vortex shedding and minimizes natural frequency oscillations of the tower. Use electrical tape to secure the sensor cables to the tower every few meters. Also tape cables to the tower above and below each guy ring. Where the cables cross each guy ring, protect the cables by wrapping them with a thick layer of electrical tape as shown in picture 3-29 below. Other good options are to use a piece of hose or rubber tubing.



Picture 3-29: Cable protection

### 3.9 ATTACH THE GUY WIRES

#### 3.9.1 Organize and layout the lifters and guy wires

On the Super 60 m XHD TallTower, there are 24 guy wires and 6 lifter wires. Both sets of guy wires and lifters are color coded for the different levels to make this job easier. **Be very careful to place all wires exactly as described below to avoid having to disassemble and re-assemble.**

Sort out and identify the different length guy wires and match them with the appropriate guy ring level and place them on the right-hand side of the tower at the corresponding guy level. Also,



make sure the front guy wires are placed opposite of the quadrant occupying the lifter securing anchor. This will ensure the front guys do not get entangled with the lifters.

Sort out and identify the different length lifter wires and match them with the appropriate guy ring level and place them on the left-hand side of the tower at the corresponding guy level.

To minimize the risk of entangling guy wires, it is recommended that back guy wires (the guy wires opposite the winch) are attached to their guy rings, rolled out, measured and marked, then secured to their anchors first (as described below in [3.9.4 Back Guy Wire Marking Distance From Guy Level](#)). Once the back guys are laid out and attached to the back anchors, prepare to attach the Back Stay Tensioning system. See [Appendix E for assembly and procedure of Back Stay Tensioning System](#).

**Table 3-3: Super 60 m XHD TallTower Guy Levels**

Guy Ring Level	Label Text	Label Color
1 Lowest Level	9.90 m (32.5 feet)	Red
2	19.36 m (63.5 feet)	White
3	28.82 m (94.6 feet)	Black
4	38.28 m (125.6 feet)	Yellow
5	47.74 m (156.6 feet)	Blue
6 Highest Level	57.86 m (189.8 feet)	Green

### 3.9.2 Guy wire roll out sequence

To ensure that no one needs to go under the tower during the lift process and no tangles occur, follow these steps when connecting guy wires:

- Shackle guy wire to tower, roll out and measure the back guy wires based on [3.9.2 Guy wire roll out sequence](#), then attach to back anchors.
- Hook up Back Stay Tensioning System and attach to correct back guy wire (more information on the Back Stay Tensioning System can be found in [Appendix E](#)).
- Shackle to tower, roll out and attach all side guy wires to side anchors. Take the time to roll out side guy wires as straight as possible then attach to side anchors using 2-3 people to hand tighten. Fasten with correct wire rope clip size.
- Shackle Lifter Wires to appropriate guy ring and leave rolled up on one side of tower.
- Shackle Front guy wires to appropriate guy ring and leave rolled up on opposite side of tower from lifter. (The Lifter wire should be shackled closer to the tower, front guy wire on top of lifter away from tower) See Picture 3-30 below.
- After the ginpole is constructed, lifters and front guy wires will be rolled out and attached.

### 3.9.3 Shackle lifter wires to the guy rings

Secure the lifter wires to the upper shackles containing the front guy wires on the top of the tower tube. Attachment of the 4<sup>th</sup> level (Yellow) lifter and front guy is shown in picture 3-30





below. Lifter should be attached closer to the tower. After attaching the lifter wires to the guy ring, keep the lifter and front guy wire rolled up until the ginpole is constructed. This will keep the lifters and front guy wires organized until it is time to roll them out.

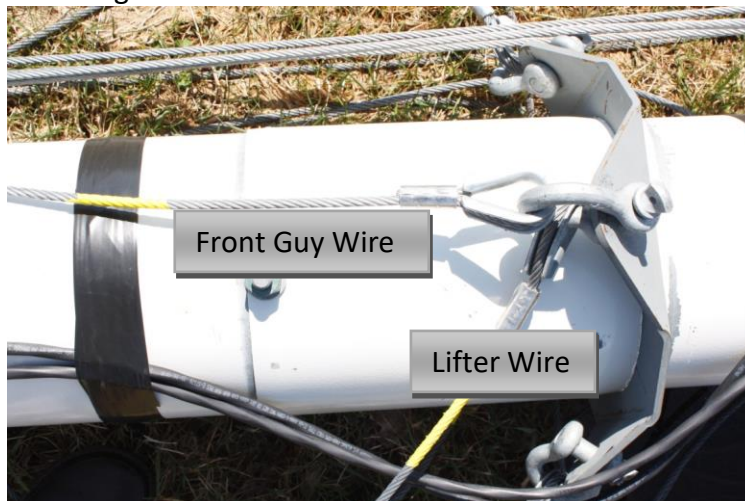

**Picture 3-30: Front guy wire and lifter wire attachment**

### 3.9.4 Back Guy Wire Marking Distance From Guy Level

The back guy wires are attached to their respective guy ring, rolled out alongside the tower, then measured and marked at the distances in the table below. Once marked, connect the back guy wires to their respective back anchor so that the mark is at the triple eye of the anchor.

**Table 3-4: Marking Distances**

Level	Marking Distance from Guy Level (ft [meter])
L1 (Lower)	151 [46.0]
L2	161 [49.1]
L3	175 [53.3]
L4	206 [62.8]
L5	227 [69.2]
L6(Upper)	251 [76.5]



If your back anchors are below grade from your baseplate, you will need to determine this height difference and add the length to the marking distance that is associated with each back guy wire level.

### 3.9.5 Roll out guy wires

Roll out each guy wire from the tower to its anchor point (All except the front guy wires and lifters). Do not allow twists or kinks in the guy wires. The guy wire and lifter coils can be uncoiled in a hand-over-hand method while walking out towards each anchor- see pictures 3-31 & 3-32 below.



**DO NOT ALLOW GUY WIRES TO BECOME TANGLED.** TANGLED GUY WIRES CAN CAUSE GUY WIRE TENSION DURING THE TOWER LIFT PROCESS THEREBY CREATING INSTABILITY AND EXCESSIVE GUY WIRE FORCES AND COULD RESULT IN SERIOUS INJURY OR DEATH. CAREFULLY FOLLOW ALL INSTRUCTIONS ON GUY WIRE ATTACHMENT TO PREVENT GUY WIRES FROM BECOMING TANGLED.



**Picture 3-31: Unroll guy wires CORRECT**



Do **not** un-spool cable off the side of the coil as shown in Picture 3-32.

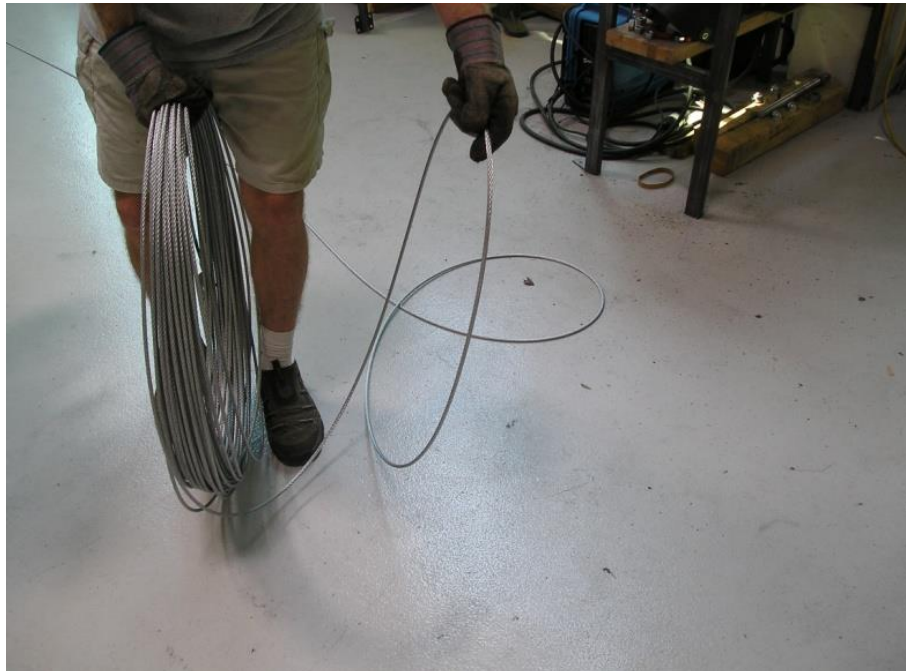

**Picture 3-32: Unroll guy wires INCORRECT**

Pass the split rings through the eye of each shackle bolt to keep the shackle pins from loosening.



**Picture 3-33: Split ring shackle bolt to shackle**

### **3.9.6 Secure guy wires to the anchors**

Secure guy wires to the back and side anchors by threading the cable through the anchor loop and clamping the cable onto itself using 3 wire rope clips. Place the wire rope clip on the wire so the saddle (the forged, grooved part) cradles the wire coming from the tower and the “U” bolt part clamps down on the dead end of the guy wire (“Never saddle a dead horse” may help you to remember how to secure the wire rope clips).



**Picture 3-34: Wire rope clip guy wires together at anchor points**



**Picture 3-35: Wire rope clip guy wires together at anchor points**

Leave a little slack in the guy wire, and tighten the wire rope clip nuts. Don't tighten the wire rope clip nuts too tightly; you will need to adjust the guy length numerous times as the tower is erected.



### 3.10 GINPOLE ASSEMBLY

#### 3.10.1 Layout the ginpole tubes

Identify the ginpole, helper ginpole tubes, and hardware.

#### 3.10.2 Attach the ginpole base tube to the baseplate

The ginpole base tube lays on top of the tower base tube. Place the ginpole base tube with the pivot pipe clearance hole between the baseplate's vertical channels. Line up the holes in the ginpole base tube with the holes in the baseplate's vertical channels and insert the pivot pipe through the baseplate clearance holes. Secure the pivot pipe with quick release pins.

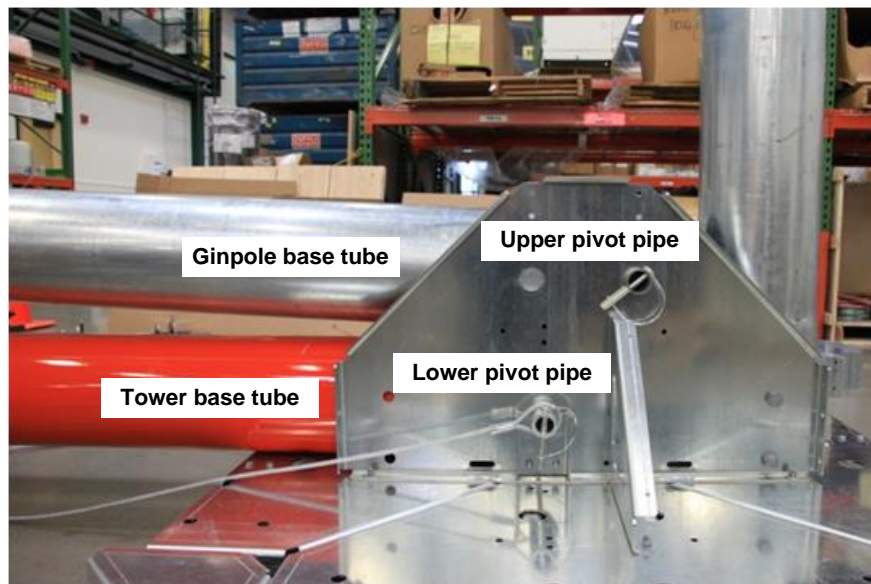

Picture 3-36: Ginpole and tower base tubes attached to baseplate

#### 3.10.3 Slide together the 10 tubes that comprise the ginpole

Slide and bolt sections together following the instructions specified in the previous section. Aligning the weld seams (visible on interior of tubes) of each tower section will make it easier to slide the sections together. Place a log, sawhorse, or other type of support underneath the 5<sup>th</sup> and the 8<sup>th</sup> or 9<sup>th</sup> section to raise the ginpole above the tower tube – make sure there is at least 0.76 m (2.5 feet) of clearance between the ground and ginpole tube #5.



**Picture 3-37: Ginpole assembly**

**NOTE:** Make sure the jumper strut center ring plates are slipped over the flared end of ginpole tube #6 prior to installing tube #7 in the build sequence. Failure to do so will require partial disassembly of the ginpole tubes because the center ring plates cannot be installed after the complete assembly of the ginpole.

#### **3.10.4 Attach the ginpole jumper strut end-flanges**

Attach the ginpole jumper strut end-flanges to the ginpole base tube. There are four (4) end-flanges per tube. Slide the end-flanges of the base tube flush against the flared end of ginpole tube #2. Use  $\frac{1}{2}$ "-13 X 1-1/4" bolts and  $\frac{1}{2}$ "-13 hex nuts to secure the end-flanges and tighten using a  $\frac{3}{4}$ " socket or open-end wrench.



**Picture 3-40: Ginpole jumper strut end-flanges**

Align the end-flanges so that upper  $\frac{5}{8}$ "-11 X 1-1/2" bolt is in the middle of the top end-flange, as shown in picture 3-41 below.



**Picture 3-41: Ginpole jumper strut end-flange bolts**

Attach the ginpole jumper strut end-flanges to ginpole tube #10, above the flared-end, as shown in picture 3-42 below. To ensure correct orientation of the end-flanges, make sure the top tube 5/8-11X1-1/2" bolt bisects the top end-flange.



**Picture 3-42: Ginpole jumper strut end-flange**



### 3.10.5 Attach the turnbuckles to the end-flanges

Attach the four (4) turnbuckles to the end-flanges affixed to the lower ginpole base tube, as shown in picture 3-43 below. Secure the turnbuckles by tightening the supplied hardware.



**Picture 3-43: Turnbuckle assembly**

**NOTE:** The turnbuckles may not tighten easily if the ginpole has been used previously or been left outside. It is recommended that you apply a small amount of anti-seize compound to the turnbuckle threads.

### 3.10.6 Attach the ginpole jumper struts

Install the  $\frac{1}{2}$ "-13X2.5" bolts through the ends of the four (4) square tube jumper struts. Tighten the  $\frac{1}{2}$ "-13 nuts using a  $\frac{3}{4}$ " socket or open-end wrench.





**Picture 3-44: Install bolts/nuts onto jumper struts**

Install the four (4) square tube jumper struts between the center rings as shown in picture 3-44. Use  $\frac{1}{2}$ "-13X2.5" inch bolts and  $\frac{1}{2}$ "-13 nuts to secure and tighten using a  $\frac{3}{4}$ " socket or open-end wrench.

**NOTE:** Make sure the jumper struts are oriented as shown in pictures 3-45-3.46 below. The top and bottom jumper struts are  $60^\circ$  apart and oriented approximately  $30^\circ$  with respect to vertical.

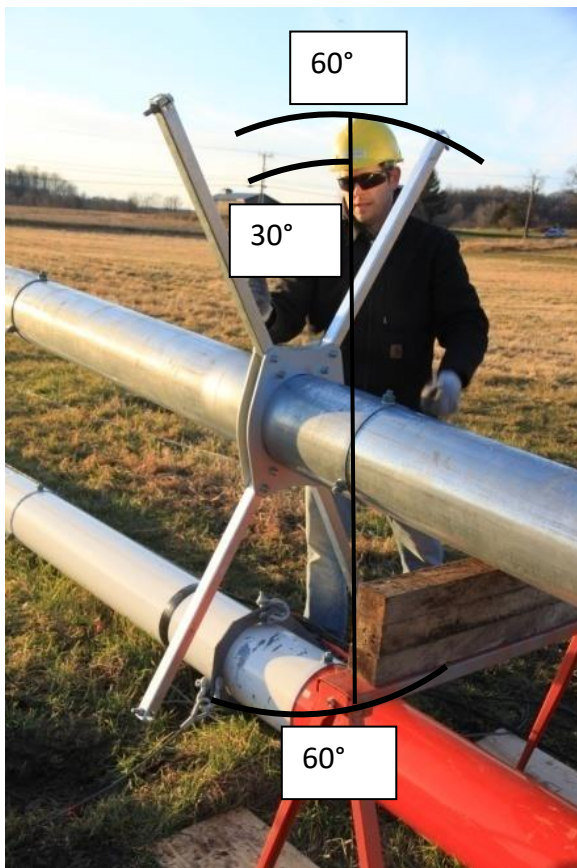

**Picture 3-45: Install jumper struts**



**Picture 3-46: Jumper strut alignment**



### 3.10.7 Attach the ginpole jumper strut cables

Locate the four (4), 54 foot long, jumper strut cables outfitted with 5/16" thimbles and 1/2" shackles. Affix the 1/2" shackles from each jumper strut cable to the available clearance hole on the top end-flange, as shown in pictures 3-47, 3-48, & 3-49 below.



**Picture 3-47: Jumper strut cable attachment**



**Picture 3-48: Jumper strut cable attachment detail**



**Picture 3-49: Threading the jumper strut cable**

Pass each jumper strut wire through the larger clearance hole at the tip of each jumper strut, as shown in picture 3-49 above and picture 3-50 below. Alternatively, you might consider passing the jumper strut wire through the clearance hole prior to inserting the  $\frac{1}{2}$ "-13X2.5" bolts and  $\frac{1}{2}$ "-13 nuts. Do not let any of the jumper strut wires cross or get tangled. Preserve the respective quadrant (upper left and right, lower left and right) for each jumper strut wire – rope attached to the upper left end-flange will pass through the upper left jumper strut and terminate on the upper left end-flange nearest the baseplate.



**Picture 3-50: Threading the jumper strut cable**

Unscrew the turnbuckles as far as possible to allow for the most tightening capability. Remove the unused bolt and nut from each turnbuckle and insert a  $\frac{5}{16}$ " thimble into the clevis of the



turnbuckle. Re-insert the bolt and nut and tighten. Now pass the 5/16" jumper strut wire rope through the thimble, pull the wire rope taught (by hand) and secure the wire rope using three (3) 5/16" wire rope clips, as shown in the pictures 3.51 & 3.52 below. The pass-through direction does not matter.



**Picture 3-51: Attach jumper strut cable to turnbuckle**

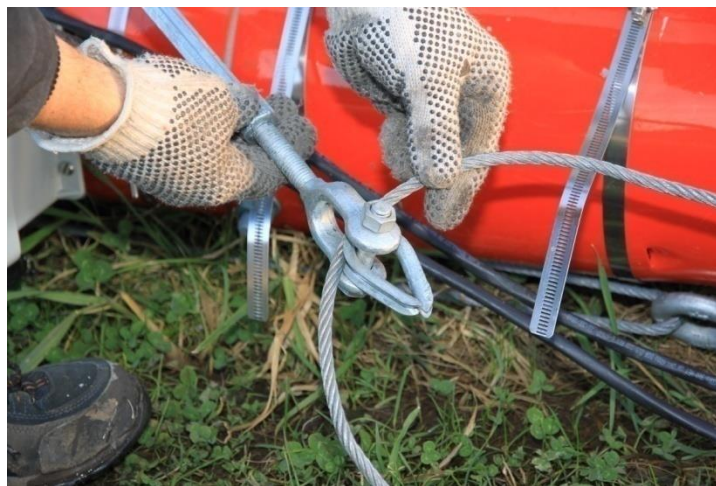

**Picture 3-52: Attach jumper strut cable to turnbuckle**

### **3.10.8 Attach the ginpole top mounting hardware**

Assemble the left and right outer rocker plates together with the shim between the plates, using the three (3) 5/16"-18 hex head cap screws and locknuts, as shown in picture 3-53 below. Loosely tighten the nuts at this time to permit sufficient clearance for the lifter thimbles.



**Picture 3-53: Ginpole rocker plates**

While one crew person slips the left and right outer rocker plate assembly through the slot (from below) at the top of the ginpole, another crew member slips the inner rocker plate through the slot (from above) and inserts the 2-1/2" diameter pivot pipe through all three plates.

**NOTE:** Make sure the plates are oriented as shown in Picture 3-54 below.



**Picture 3-54: Ginpole rocker plate assembly**



Secure the 2-1/2" diameter pivot pipe with quick release pins on each end.



Picutre 3-55: Secure ginpole rocker plate pivot pipe



### 3.10.9 Attach the Lifter Wires & Front Guy Wires

## NOTICE

In order to avoid the front guy wires getting tangled on the upper tower bolts during the lift, attach the front guy wires to the lifter wires at the top of the ginpole.

Carefully lay out the lifters and front guy wires one level at a time starting at the lowest level (RED). In an orderly fashion, attach to guy ring and roll out the lifter wire on the left-hand side of the tower back towards the base and the front guy wire on the right side. When you reach the other side of the baseplate, keeping the two wires separate but lying flat near each other, use something (piece of tape or marker) to mark on the front guy wire the total length of the lifter. Leaving the front guy wire on the ground, take the lifter and attach the end to the rocker plate as shown in the pictures below.

Next, take the level one front guy wire, **add 12-16 inches** to the mark you have made and attach that length to the matching level lifter. Attach beyond the colored tape, approximately 6 inches below the rocker plate with a wire rope clip. This will create a little bit of slack so the front guy



wires are never tight during the lift. Continue this method one level at a time moving up the tower. Take your time to not tangle or weave any wires. Picture 3-58 below shows what all guy wires and lifters of an 80 meter tower look like when the tower is assembled and after the tower is vertical.

There are six (6) lifters employed on the Super 60 m XHD TallTower. The designation and markings are shown in Table 3-5 below.

**Table 3-5: Super 60 m XHD TallTower Lifter Marking**

Lifter No.	Lifter Color	Coupler Plate Hole
6	Green	6 (top – away from base of tower)
5	Blue	5
4	Yellow	4
3	Black	3
2	White	2
1	Red	1 (bottom – toward base of tower)

Insert the thimble of each lifter between the left and right outer rocker plates, as shown in Picture 3-56. Secure each thimble using a 5/8"-11X2" bolt and 5/8"-11 nut and tighten using a 1-1/16" socket or open-end wrench.

**NOTE:** Be sure to connect the lifters in the proper order and make sure they are not tangled with each other or guy wires. In pictures 3-56 below, the shortest lifter (marked RED (see Table 3-5)) attaches to the rocker plate closest to the tower baseplate; the longest lifter (marked GREEN) attaches to the rocker plate farthest from the tower baseplate.

**NOTE:** After all the lifters have been installed in the rocker plate assembly, tighten the three (3) 5/16"-18 hex head cap screws and nuts. Tightening these nuts too soon will prevent other lifters from fitting between plates.





**Picture 3-56: Lifter attachment to rocker plates**



**Picture 3-57: Correct lifter attachment to rocker plates (60 m tower)**

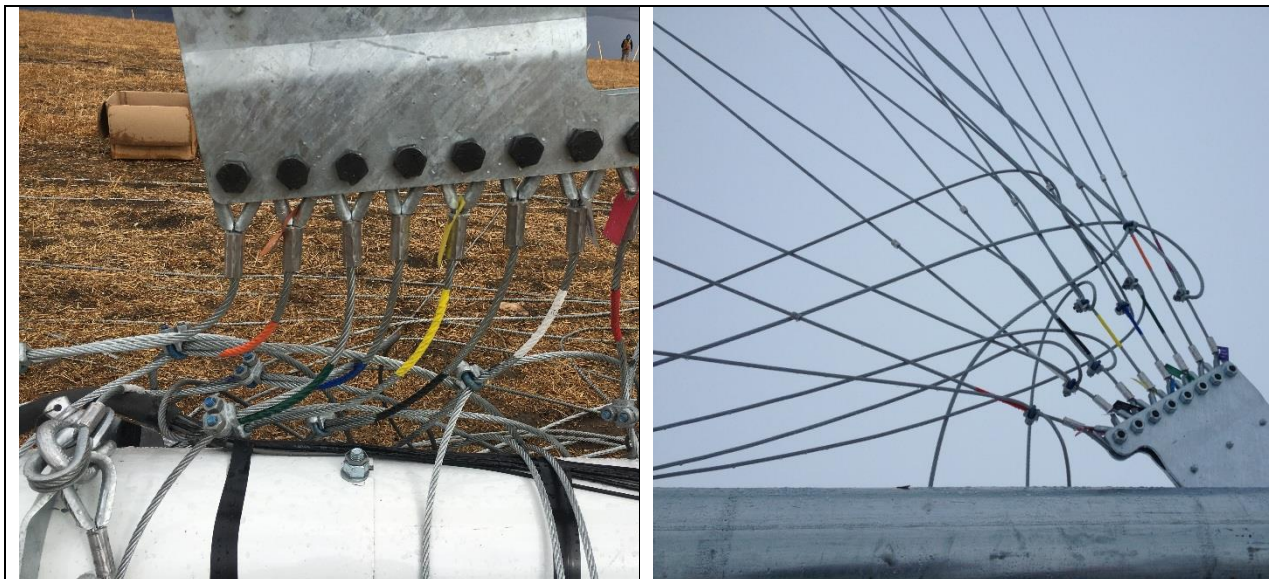

**Picture 3-58: View of front guy wires attached to lifters (80 m tower) before and after tower raising**

#### 3.10.10 Critical Installation Step: Attach the pulley blocks to the ginpole

It is mandatory that installers use a five (5) part line to raise the NRG Super 60 m XHD TallTower. The use of a 5-part line ensures the lifting load is properly distributed to the rocker plate.

Attach the two (2) 5" pulley blocks to the ginpole. The assembly sequence is as follows:

- Insert one (1) 5/8" shackle into each of the three (3) available holes in the inner rocker plate. The winch cable dead-end is attached to the lower shackle (as shown in picture 3-60 below and described later).
- Attach one (1) 5" pulley block to each of the middle and upper 5/8" shackles.
- Attach two (2) 1/2" shackles, one on each side of the pulley block, to the middle 5/8" shackle. Secure one (1), 3/16" guy wire thimble (ginpole cables) to each of the two (2) 1/2" shackles.



The assembly should look like the one shown in below.



**Picture 3-59: Correct block pulley assembly**

### **3.10.11 CONFIGURE THE HELPER GINPOLE**

Locate the two (2), 254 mm (10 inches) diameter, thin-wall (12 GA), unpainted tubes, with only flared and lanced joints. These tubes comprise the helper ginpole. The base tube of the helper ginpole does have two (2) bolt holes in the flared end to accommodate two (2) 30.5 cm (12 inches) long through-bolts.

Assemble the top and bottom helper ginpole tubes together on a flat surface by sliding the tapered end of the bottom tube into the flared end of the top tube. Insert the  $\frac{3}{4}$ "-10X12" long bolt through one of the top tube clearance holes. Slide the bolt through two of the provided spacers, then the five (5), 5-inch wire rope pulleys, through the second set of spacers, and, finally, through the second top tube clearance hole. Secure using the  $\frac{3}{4}$ "-10 nut supplied and tighten using a 1-1/8" socket or open-end wrench.

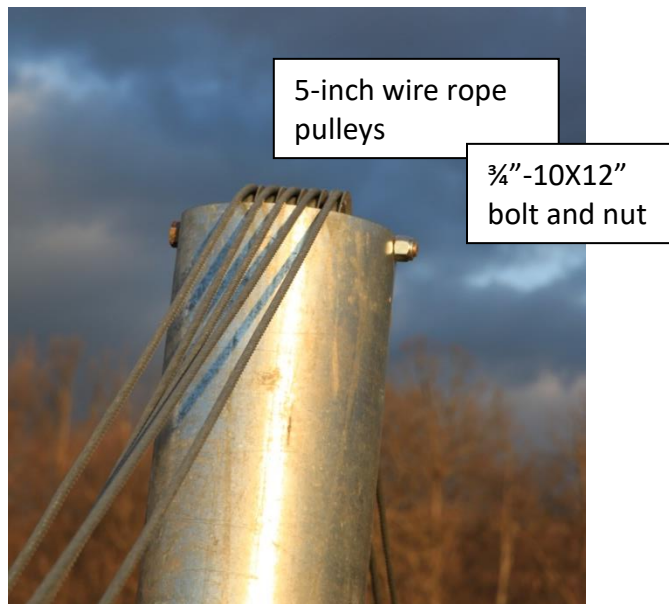

**Picture 3-60: Helper ginpole pulleys with winch cable fully reeved**

Tilt-up the helper ginpole assembly, making sure the (unused) clearance holes are on the bottom and the V-belt pulleys point to the sky. Walk the helper ginpole between the uprights of the baseplate behind the tower and ginpole base tubes, aligning the clearance holes of the tubes and uprights. Insert the two (2)  $\frac{3}{4}$ "-10X12" bolts through the holes on the helper ginpole tube and secure with  $\frac{3}{4}$ "-10 nuts. Tighten the nuts using a 1-1/8" socket or open-end wrench.



**Picture 3-61: Attach helper ginpole**

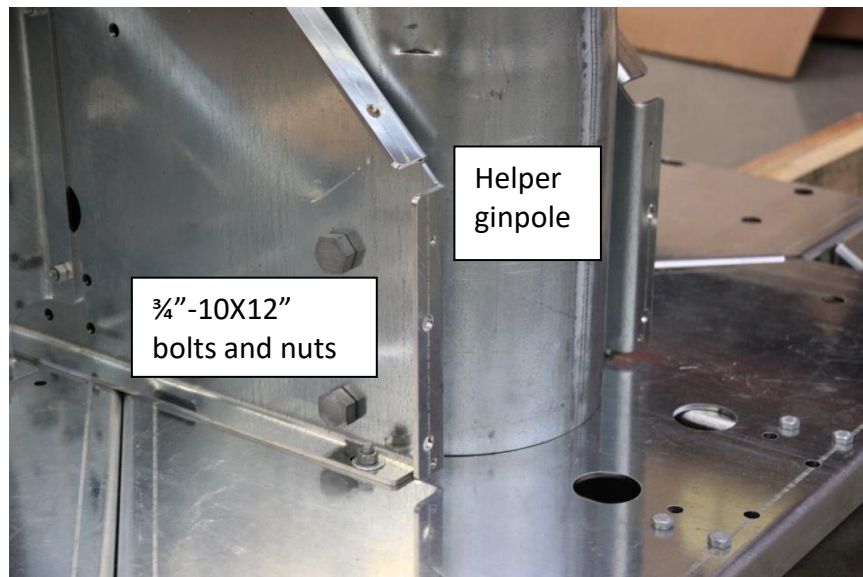

**Picture 3-62: Helper ginpole attached with bolts/nuts**

The completed baseplate and base tube assembly should look like the one shown picture 3-63 below.

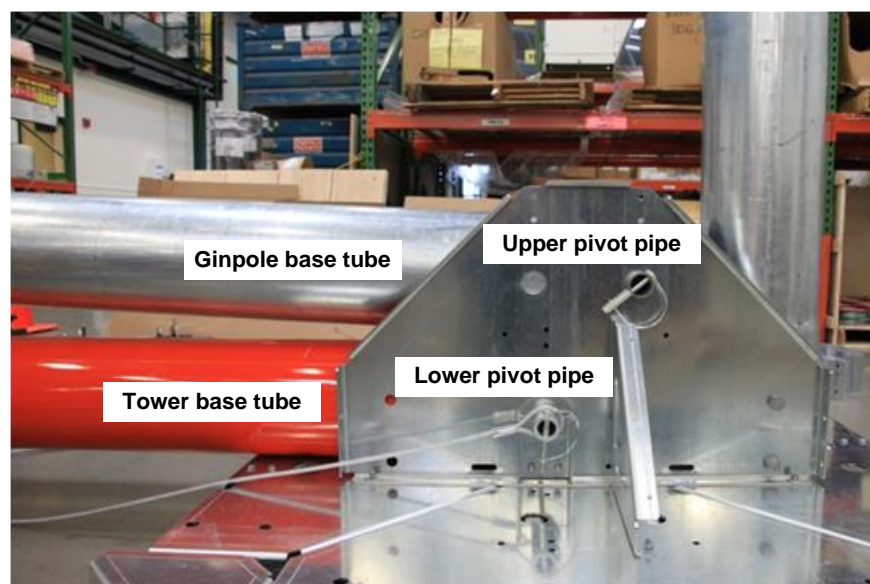

**Picture 3-63: Complete baseplate and tower assembly ready for raising**



### 3.10.12 CONNECT THE CURTIS BRIDLE ASSEMBLY TO THE 3 BLOCK PULLEY ANCHORS

The NRG Systems supplied Bridle kit (NRG Kit # 18046) consists of the following equipment:

- (3) 5/8" Shackles
- (2) Ten foot lengths of 3/8" wire rope
- (4) 3/8" Thimbles
- (2) 3/8" Sleeves (already swaged)
- (4) 3/8" Wire rope clips

Two lengths of wire rope will connect the three block pulley anchors together, to minimize deflection during the tower raise.

- Thread the swaged end of the (1) wire rope length onto a shackle, then connect it to the first anchor rod below the triple eye head.
- Thread the swaged end of the (1) wire rope length onto a shackle, plus (1) loose thimble, then connect it to the middle anchor rod, below the triple eye head.
- Thread the remaining loose thimble onto the last shackle and connect it to the remaining anchor rod, below the triple eye head.
- Stretch the end of the cable through the loose thimble and shackle and tighten back to itself, securing with (2) wire rope clips.
- Repeat the process for the second length of wire rope.

Your setup should resemble the drawing below:

### 3.10.12 SETTING UP THE WINCH AND HYDRAULIC POWER UNIT (HPU).

The NRG Systems supplied winch kit (NRG Kit # 4915) consists of the following equipment:

- Bloom Manufacturing Inc. Winch Model LS10H-6.2T-XL14-20-5884
- Drum spooled with 228.6 m (750 feet) of 3/8 inch diameter wire rope (per Federal Spec RR-W-410F)
- Winch support plate [to mount to 51 mm (2 inch) receiver hitch]
- Foster Manufacturing Corp. HPU Model 13-1-8GC



**THE WINCH FOR THE 80 METER XHD TALLTOWER IS ONLY COMPATIBLE WITH THE SUPER 60 XHD AND 80 M TALL TOWERS. IT IS NOT COMPATIBLE WITH ANY OTHER NRG TALLTOWERS AND SHALL NOT BE USED FOR APPLICATIONS OTHER THAN RAISING AND LOWERING THE NRG 80 METER XHD OR THE SUPER 60 METER XHD TALLTOWERS.**



**NEVER USE A Super 60 METER TALLTOWER WINCH FOR THE FIRST TIME TO LOWER A TOWER; ALWAYS USE IT FOR THE FIRST TIME TO RAISE A TOWER. USING A Super 60 METER TALLTOWER WINCH FOR THE FIRST TIME TO LOWER A TOWER CAN RESULT IN A DANGEROUS LACK OF WINCH CABLE TENSION WHICH COULD LEAD TO ENTANGLEMENT OR BREAKAGE AND SERIOUS INJURY OR DEATH COULD OCCUR. USING THE WINCH FOR THE FIRST TIME TO RAISE A TOWER CREATES PROPER WINCH CABLE TENSION FOR SUBSEQUENT USES.**



**Picture 3-64: Super 60 Meter Bloom winch with mounting plate**

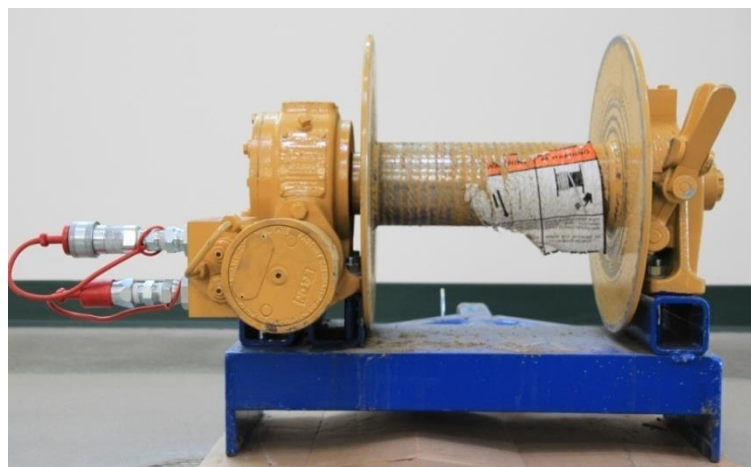

**Picture 3-65: Super 60 Meter Bloom winch with mounting plate**



Picture 3-66: Foster Manufacturing Corp. HPU Model 13-1-8GC

## NOTICE

Use only NRG Systems approved lifting devices when raising or lowering NRG Systems TallTowers. NRG approved lifting devices have been carefully designed to provide sufficient line pull strength and safety margin. NRG does not support the use of a substitute winch. Please contact NRG Technical Services for additional information.

A recommended set-up for this equipment is shown in picture 3-67.

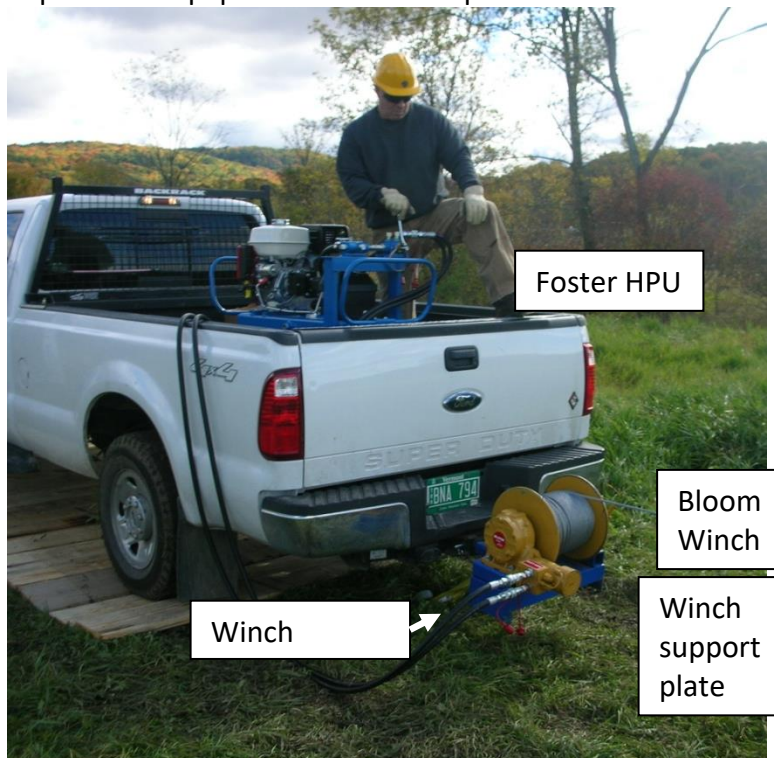

Picture 3-67: Winch set-up





Verify that the fleet angle – the angle between the winch and the first turning block is less than 3°. Setting the fleet angle to less than 3° (straight as possible) will aid in the proper level winding of the winch cable on the drum. An example of a proper fleet angle is shown below.



**Picture 3-68: Correct winch cable fleet angle**

### **3.10.13 Anchor the winch**

Secure the winch support plate using a sling [with a minimum working load limit of 26.7 kN (6000 lbf)].

**NOTE:** Even though the winch and support plate are mounted to a vehicle, it is imperative the winch assembly be secured to the winch anchor.

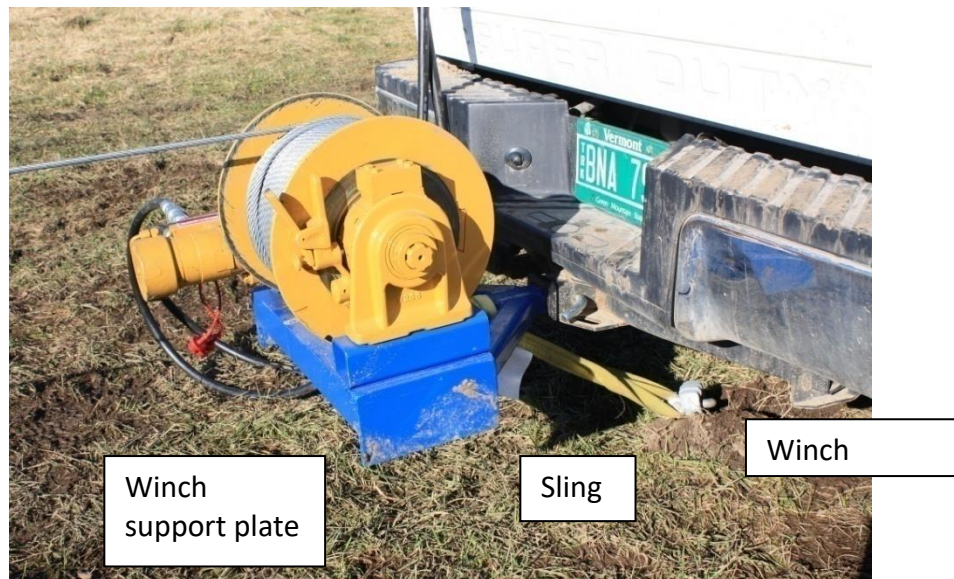

**Picture 3-69: Correct winch assembly attached to winch anchor**



**ALWAYS SECURE THE WINCH TO A WINCH ANCHOR. FAILURE TO USE A WINCH ANCHOR COULD CAUSE EXCESSIVE LOADS ON THE VEHICLE USED TO SUPPORT THE WINCH AND WINCH PLATE. EXCESSIVE LOADS CAN RESULT IN THE VEHICLE BEING HOISTED IN THE AIR CAUSING SERIOUS INJURY OR DEATH OR PROPERTY DAMAGE. NEVER RELY ON AN UNSECURED WINCH AND SUPPORT PLATE – ALWAYS USE A WINCH ANCHOR.**

### **3.10.14 Reeving the winch cable**

Operate the winch in reverse to un-spool the winch cable for reeving. The pictures below provide a global view of the reeving process.

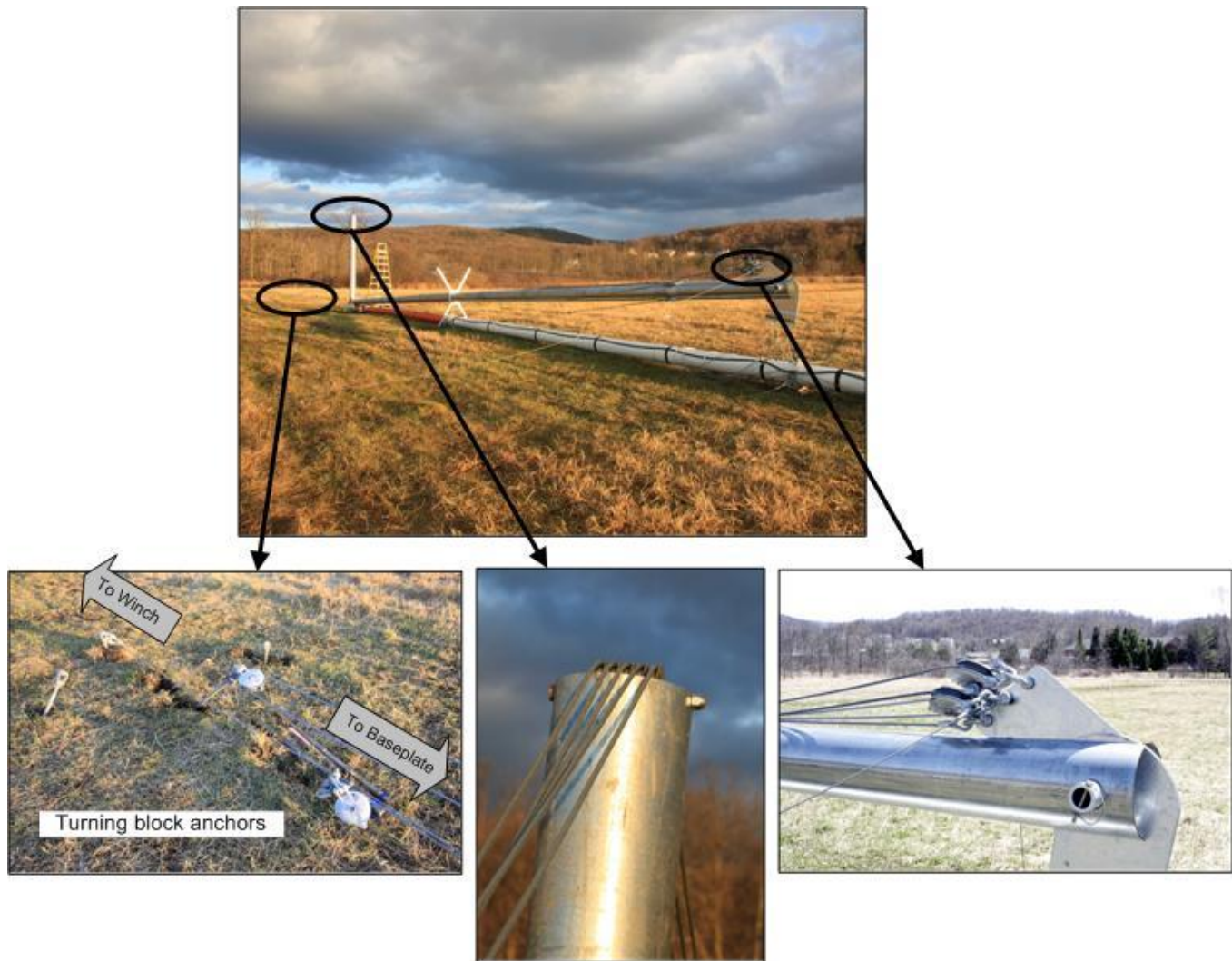

Picture 3-70: Correct reeving of the winch cable

Picture below is taken when the tower is vertical and the ginpole is nearly horizontal (opposite its start position). This picture is out of sequence, but the photograph shows clearly the reeving sequence because all five (5) pulley blocks are in close proximity.

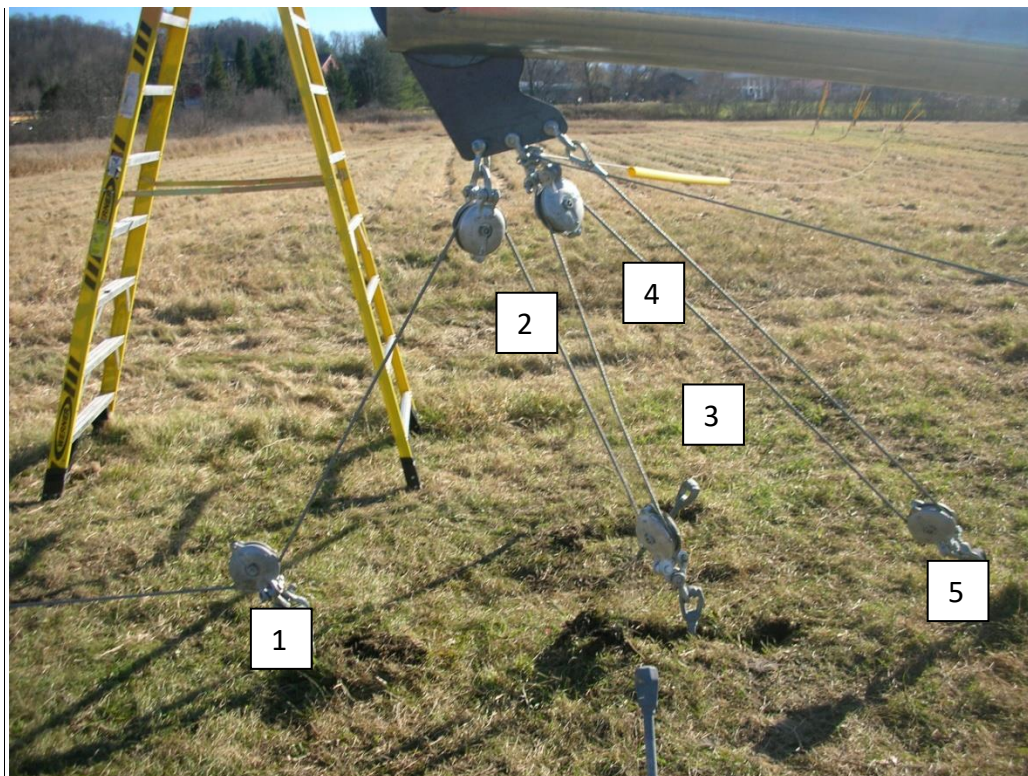

**Picture 3-71: Proper winch cable reeving through block pulleys**

**IMPORTANT:** The direction of the winch cable through the pulley blocks is important to prevent the block and tackle from binding up. Follow the instructions included below.

Reeve out the winch cable and route as follows:

- Through the pulley block on the ground nearest the winch (pulley #1) [see Picture 3-72]
- Over one of the helper ginpole sheaves (start on one side and work your way across the sheaves, do not randomly place the winch cable across the sheaves)
- Through the pulley block at the top of the main ginpole (pulley #2) [see Picture 3-73]
- Over another helper ginpole sheave
- Through the pulley block on the ground attached to the middle anchor (pulley #3) [see Picture 3-74]
- Over another helper ginpole sheave
- Through the pulley block on the main ginpole (pulley #4) [see Pictures 3-75 & 3-76]
- Over another helper ginpole sheave
- Through the pulley block on the ground attached to the middle anchor (pulley #5) [see Picture 3-7]
- Over another helper ginpole sheave
- Ending at the top of the main ginpole [see Picture 3-78]

**Note:** To open the supplied pulleys, remove the pin from one side of the pulley.



**Note:** When putting the winch cable over the top of the helper gin pole, it is recommended to place the winch cable in the V-belt pulleys in an orderly fashion, occupying the right-most sheave first, followed by the next closest sheave, and so on.

The following photographs illustrate the winch cable reeving sequence.

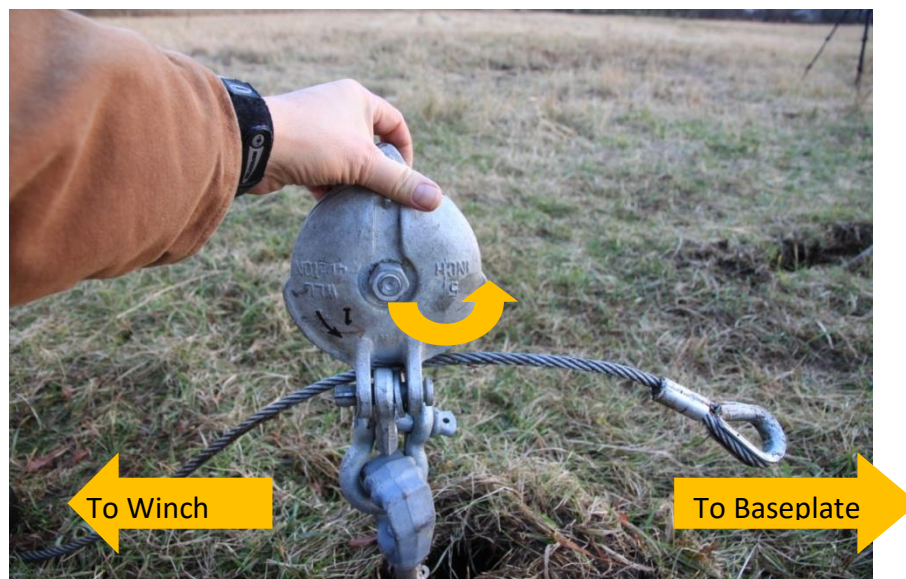

**Picture 3-72: Reeving through pulley #1**

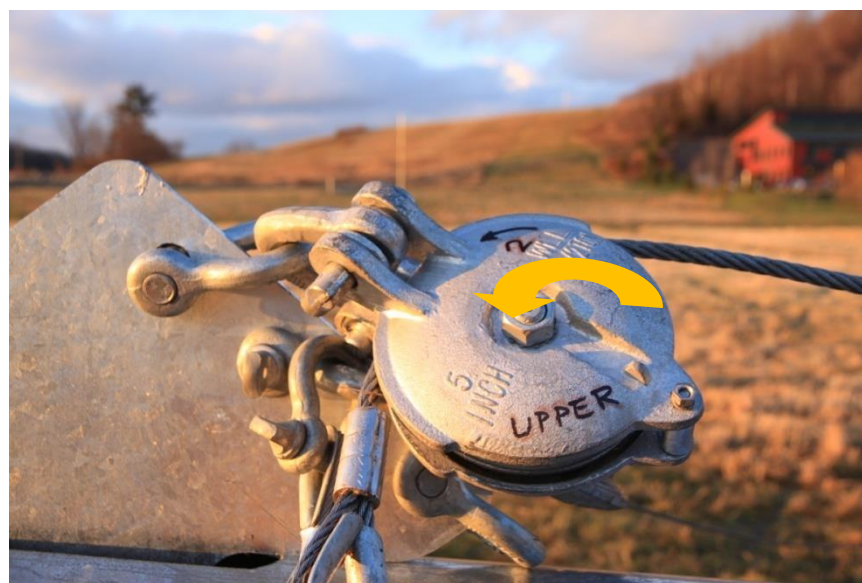

**Picture 3-73: Reeving through pulley #2**

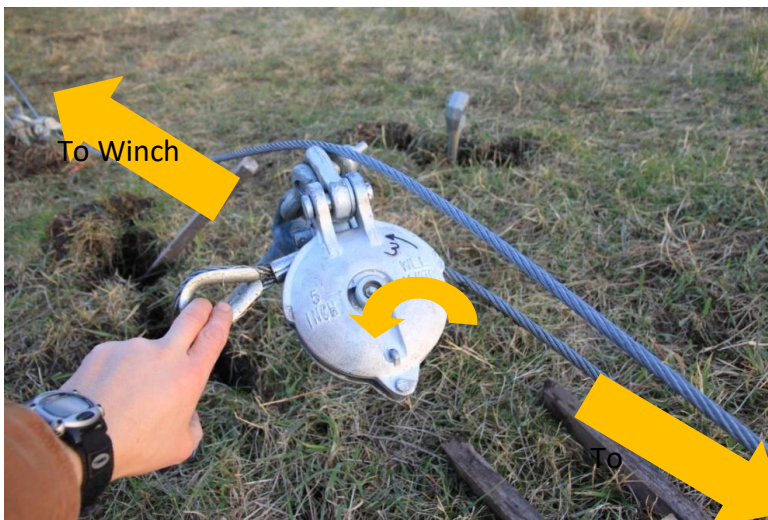

**Picture 3-74: Reeving through pulley #3**



**Picture 3-75: Reeving through pulley #4**



**Picture 3-76: Reeving through pulley #4**

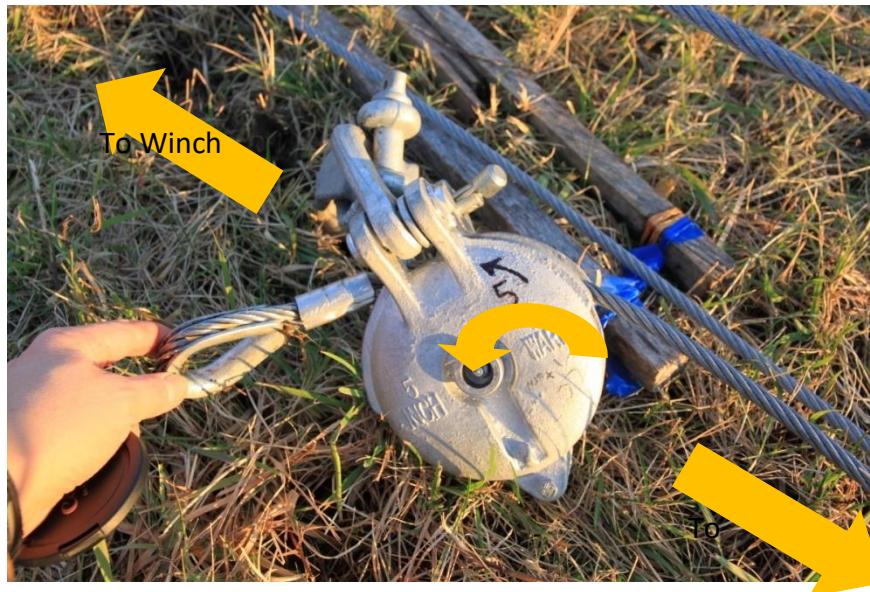

Picture 3-77: Reeving through pulley #5



Picture 3-78: Affixing dead-end to ginpole rocker plate

### 3.10.15 Critical Installation Step: Tensioning the ginpole jumper strut cables

Once the cable has been reeved, prop up ginpole with supports until it is plumb straight (not drooping or curving up), and then tension the strut cables. After the ginpole is vertical, it is impossible to access all of the jumper strut cables in order to tension them.

Incrementally tighten the turnbuckles. Using two (2) adjustable wrenches (one to resist rotation, the other to rotate the turnbuckle body), tighten the turnbuckles (in turn tightening the jumper strut wires).



**Picture 3-79: Tightening turnbuckles**

Incrementally tighten all four (4) turnbuckles (in succession) and measure the tension in the jumper strut wire using the Loos & Co Model PT-3 Tension Gauge, as shown in the picture below. Continue to adjust the turnbuckles until the tension in the jumper strut wires is 44.5 kN (1000 lbf). The scale on the Tension Gauge should read 20, with an acceptable range of between 19 and 22 as shown below.



**Picture 3- 80: Correct use of tension gauge**

Best practice from results in the field are to tighten the lower 2 jumper strut cables (closest to the ground) to 22 (1130 lbf). Tighten the top 2 jumper strut cables to 20 (1000 lbf).



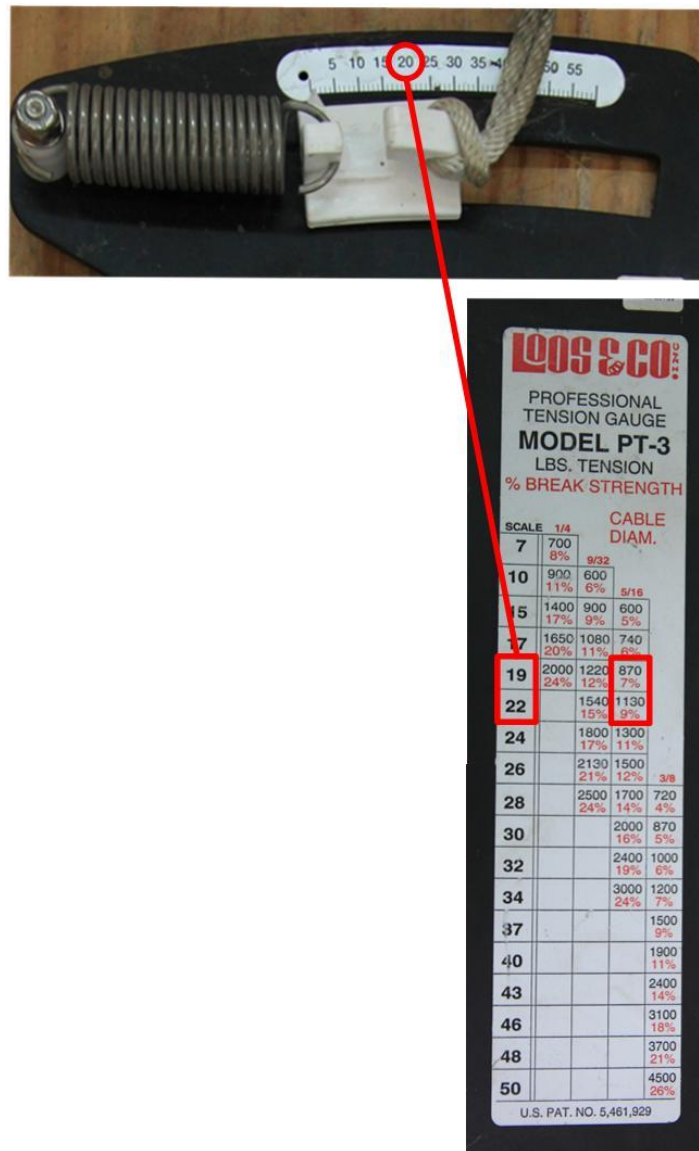

Picture 3-81: Tension Gauge

## Chapter 4: Installation Process

### 4.1 GINPOLE TILT-UP

#### 4.1.1 Confirm all guy wires, lifters and shackles are secure

Carefully double check all connection points to make sure everything is secure before starting to lift the ginpole.



#### 4.1.2 Lift the ginpole

It is critical during the ginpole and tower lift that the 3/16" diameter side guy wires remain snug but not overly taut. Monitor the ginpole side guy wires to verify there is a slight sag in them at all times during the lift. If necessary, adjust the ginpole side guy wire tension by adding or removing slack.

Make sure the ginpole remains centered side-to-side. If the pole is off center, carefully adjust the wire ropes to re-center. As the ginpole comes up, watch the lifters to make sure they are not caught on objects (e.g., tower tube bolts, booms, stumps, debris, rocks, equipment, etc.). Also check that they are not entangled. When the ginpole is half-way erected, remove the helper ginpole. Continue lifting. As the lifter wires tighten, **STOP**.

Do not lift the tower yet. Check that the shackles are not twisted at the guy rings.



Picture 4-1: Correct time to check for winch cable twists-if all is good, remove the helper ginpole



Picture 4-2: Ginpole vertical



## 4.2 TOWER TILT-UP

### 4.2.1 Understanding Guy Wire Tensioning DURING TallTower LIFT (Do not raise the tower yet)

As a tower is raised, even if the anchors are placed in precisely their correct positions, and even if the site is perfectly level, some guy wires will tighten and some will loosen as the tower is raised. The same is true as a tower is lowered on the same site. For this reason, guy wire tension must be checked and adjusted as needed to maintain uniform tension until the tower installation procedure is complete.



**ALWAYS MONITOR AND MAINTAIN PROPER TENSION OF SIDE GUY WIRES DURING GINPOLE AND TOWER LIFTING. IF SIDE GUY WIRES ARE SUBJECTED TO EXCESSIVE TENSION THEY CAN BREAK CAUSING A SUDDEN AND DANGEROUS INSTABILITY OF THE TOWER. SERIOUS INJURY OR DEATH OR PROPERTY DAMAGE COULD RESULT. TOO LITTLE TENSION CAN RESULT IN TOWER DAMAGE DUE TO BUCKLING. IT IS THEREFORE CRITICAL TO ALWAYS MONITOR AND MAINTAIN PROPER SIDE GUY WIRE TENSION DURING THE GINPOLE AND TOWER LIFTING PROCESS.**

**Note:** Refer to the Section entitled *4.5.1 Guy Tension Check* for a description of methods to measure guy tension.

A guy wire that becomes too tight can put very high forces on both the anchor and the tower. This force can rapidly grow if the tower lifting or lowering procedure continues. These high forces can suddenly buckle the tower and cause it to collapse, endangering the tower installation crew and possibly damaging vehicles or equipment nearby.

Ideally, one should strive to maintain the tower as straight as possible during the lift. Never exceed the maximum permissible tower deflections listed in the 4.3.2 Critical Installation Step: Permissible **Deflection**.

It is critically important that proper tension be maintained on side guy wires at all times during the lifting procedure to provide side support for the tower. Too little tension can allow the tower to buckle to the side. Too much tension may cause failure of the tower, anchors, or guy wires. Refer to the sections entitled *4.5.1 Guy Tension Check and Adjustment* for instructions on measuring and

Be sure that guy wires do not get caught on tree branches, roots, rocks, or other obstructions.

This sequence of observing, communicating observations, issuing commands to guy wire tenders, adjusting the side guy wires, and re-tightening wire rope clips must be well understood before lifting a tower. The sequence will be repeated many times before a tower installation is completed.



#### 4.2.2 Adjusting Guy Wires

Included in the NRG Installation Tool Kit (Kit # 4813) are the following mechanical devices, used to assist in adjusting the guy wires:

- Klein Tools, Inc. Chicago Grip (PN 1659-20)
- Lug-All Come-Along (Model 115-R)

#### 4.2.3 Loosening Guy Wires

As the tower is raised, the side guys may become tight. To loosen the wire rope, follow these steps:

- Hook one end of the come-along to a 3/4" shackle affixed to the anchor rod, as shown in the pictures below. Do not hook the come-along through the triple-eye as the transfer loads will pinch the guy wire and prevent loosening.
- Let out several feet of slack in the come-along and set it on the ground.
- Clamp the Chicago Grip to the guy wire approximately 0.6 – 1 m (2 - 3 feet) above the upper wire rope clip. Make sure the loop on the Chicago Grip points down.
- Attach the other hook of the come-along to the loop of the Chicago Grip.
- Crank the come-along to pull tension in the mechanical devices until the wire rope segment that supports the wire rope clips goes slack.
- Loosen the wire rope clips.
- Reverse the direction of the come-along and let out sufficient wire rope for loosening.
- Re-tighten the wire rope clips.
- Continue to let out slack on the come-along until the load is transferred to the wire rope clips.
- Repeat as necessary to create the proper cable tension.



**Picture 4-3: Come-along and chicago grip attachment**



**Picture 4-4: Use a shackle to aid in attaching come-along without pinching cables**

#### **4.2.4 Tightening Guy Wires**

To tighten the guy wires, reverse the procedure outlined in the section entitled *4.2.3 Loosening Guy Wires*.

#### **4.2.5 Monitor the weather**

It is important to monitor the weather on the day of the lift. If excessive winds higher than 10 m/s gusts are occurring, it may be a good idea to wait until the winds die down before lifting the tower.



CAREFULLY MONITOR ANY WIND DURING THE LIFT AS WIND BLOWING IN THE DIRECTION OF THE LIFT (TOWARD THE WINCH) CAN CAUSE DANGEROUS INSTABILITY AND A LOSS OF CONTROL OF THE TOWER. IF THE TOWER BECOMES UNSTABLE DURING THE LIFT, SERIOUS INJURY OR DEATH CAN OCCUR. ALWAYS MONITOR BACK GUY WIRE TENSION DURING THE LIFT TO ENSURE PROPER RESISTANCE IS PROVIDED TO PREVENT INSTABILITY.

### **4.3 LIFTING THE TOWER**

The tower lift consists of two (2) distinct phases:

- Tower Lift from zero to 60 degrees
- Tower Lift from 60 degrees to 90 degrees using the Back Stay Tensioning System

Below is a detailed description of each the the two (2) phases.

#### **4.3.1 Phase 1: Tower Lift from 0° to 60°**

When all crew members are ready, under the direction of the crew leader, the winch operator will begin to lift the tower.

The winch operator should make sure the cable winds evenly on the winch drum.



**ALWAYS MONITOR THE WINCH CABLE TO ENSURE IT WINDS ONTO THE WINCH DRUM EVENLY.** UNEVEN WINDING COULD RESULT IN CABLE CROSSOVER AND CABLE DAMAGE OR FILL THE WINCH DRUM PREMATURELY. TO AVOID DAMAGE TO THE WINCH CABLE AND PROVIDE FOR SUFFICIENT CABLE LENGTH DURING THE TOWER RAISING PROCESS, HAVE THE WINCH OPERATOR ENSURE EVEN WINDING ONTO THE WINCH DRUM.

Lift the tower about 1 m (3 feet) off the ground while checking side guy tensions. The lifters are set up to produce a slight bow in the tower, with the top approximately 0.6 m (2 feet) higher than the middle (we refer to this as a “positive curve”). This is normal, and it needs to be maintained throughout the entire lift to avoid tower buckling or collapsing.

Adjust the side guy wire tensions to straighten the tower to prevent the tower from either falling off to one side or bowing which could damage the tower.



**THE TOWER MUST REMAIN STRAIGHT SIDE-TO-SIDE AND MAINTAIN A POSITIVE CURVE AS DESCRIBED ABOVE.** FAILURE TO MAINTAIN THE PROPER SHAPE CAN CAUSE THE TOWER TO COLLAPSE, ENDANGERING THE CREW AND EQUIPMENT. NEVER EXCEED THE MAXIMUM PERMISSIBLE TOWER DEFLECTIONS (LISTED BELOW IN THE 4.3.2 Critical Installation Step: Permissible **Deflection**) AT ANY POINT DURING THE LIFT.

#### 4.3.2 Critical Installation Step: Permissible Deflection

Tower deflection shall not exceed the following maximum permissible deflections:

Tower deflection  $\leq$  0.25 meters (0.83 feet) or one (1), 10” tube diameter, between any one (1) guy level

Tower deflection  $\leq$  0.76 meters (2.5 feet) or three (3), 10” tube diameters, between four (4) guy levels

Tower deflection  $\leq$  1.5 meters (5 feet) or six (6), 10” tube diameters, across the entire tower

Ginpole deflection shall not exceed 0.15 meters (0.5 feet) or ½ of one (1), 10” tube diameter

If the tower or ginpole deflection approaches the maximum permissible limits, **STOP** the lift and assess the situation. What is causing the deflection? Is a back guy snagged? Are the back guys uniformly tensioned? Understand the cause of the deflection and correct the problem. Verify tower and ginpole deflections are well within the maximum permissible limits prior to proceeding with the tower lift. If the lateral tower deflection exceeds the limits, the side guys should be adjusted to straighten the tower.

**Watch the winch anchors for movement.** The maximum lifting force will be experienced when the tower is first lifted a few feet off the ground. If the winch anchors do not hold, immediately lower the tower. If the winch anchors do not hold under the tower lift, either the anchors were



installed incorrectly or another type of anchor is needed. See *Appendix B: Anchoring Guidelines* for more information.

**Watch the tower baseplate for movement toward the winch.** If the baseplate slips during the first part of the tower lift, immediately lower the tower. Check that the anchor and bridle assembly are attached correctly to the pivot pipe of the base tube, there should not be movement of the baseplate during the tower erection.

If everything looks acceptable, continue to lift the tower a little at a time, checking tower side guy tension throughout the lift. At times, it may be necessary to adjust the side guy wire tension, particularly if the side guys are above, below, or otherwise out of line with the tower pivot. In addition, regularly check the ginpole side guys to make sure their tensions are roughly equal and not too tight - verify there is a slight catenary in them at all times during the lift. If necessary, adjust the ginpole side guy wire tension by adding or removing slack. Do these checks and adjustments **ONLY** when the winch is stopped. See the sections entitled *4.5.1 Guy Tension Check* and *Adjusting Guy Wires* for instructions on measuring and adjusting guy tension.

Throughout the lift, the ginpole must remain in a straight line as viewed from the winch. If it leans to either side, the cause should be determined and corrected. The safety wire cable tension should be adjusted as needed to keep the ginpole centered. When adjusting the safety wire cable tension, lengthen the *loose* wire rope and shorten the *tight* wire rope (sounds backward, but it is correct). Do not allow the ginpole to be at a severe angle to the base plate pivot since the pivot loads will be all on one side of the gin pole. In this case, lower the tower, and then realign the tower with respect to the winch and/or level the baseplate as needed. Extreme imbalance in the ginpole side guys may overload the ginpole, resulting in ginpole collapse.

Work slowly and smoothly. Fast, uneven movements tend to make the tower bounce, shake or swing. *Be sure that communication between all members of the lifting team is clear and concise.* Continue lifting and adjusting until the tower is 60 degrees above horizontal (just above the half-way point). **STOP.**

#### **4.3.3 Phase 2: Tower Lift from 60° to 90° using the Back Stay Tensioning System**

Beyond 60 degrees above horizontal, it is absolutely essential that proper tension be maintained on all back guy wires during the last part of the lift. Utilizing the Back Stay Tensioning System is required to maintain measured tension on all back guy wires. The tower will lift very easily at this point because the weight of the ginpole will be enough to tip the tower with little effort from the winch. Any wind blowing in the direction of the lift will also reduce the load on the winch; excessive wind in the direction of the lift can lead to a loss of control of the tower. *Therefore, the crew must control the lift from this point by utilizing the Back Stay Tensioning System (see [Appendix E](#) for full procedure).*

Lifting from 60° to 80° uses the Back Stay Tensioning System with a maximum tension on the scales of 200 lbf.



Lifting from 80° to 90° uses the Back Stay Tensioning System with a maximum tension on the scales of 150 lbf. Reference Appendix E for the full procedure.

Follow the procedure in Appendix E for the remainder of the lift. This will bring you to the point of transferring your front guy wires and straightening your tower.

#### **4.4 ATTACHING FRONT GUY WIRES**

When the top of the tower is over the baseplate and nearly vertical, it is time to transfer the Front Guy Wires to the front anchors. Prior to attaching the front guy wires to the front anchors, set all back guy wire load scales to 100 lbf. If all procedures have been followed correctly, the front guy wires are attached to the lifters at the top of the ginpole. One-by-one, start with front guy #6 (top level) and work down the tower. Detach the front guy wire and make sure it is on the opposite side of the ginpole in relation to where the lifter anchor is located. If this is not done correctly for each front guy wire, they will tangle with the lifters when the lifters are transferred to their anchor. Once you have the front guy wire on the correct side of the ginpole, walk it out and attach to the correct front anchor. Hand tighten using multiple people. Repeat this process until all 6 front guy wires are attached to the front anchors.

#### **4.5 PLUMB AND STRAIGHTEN TOWER**



**Picture 4-5: Straightening your tower**

Utilizing the back guywire tensioning system, plumbing the tower has become more efficient.

The back guywire tensioner provides constant tension to the back guywires during the tower plumbing and straightening process.





Prior to transferring the front guy wires, all load scales were set to 100 lbf  $\pm$  10 lbf. Personnel stationed at the back stay tensioners shall monitor and maintain tension on all load scales during the plumbing and straightening process.

Using a carpenter or digital level, measure the verticality of the base tube. Adjust the lower level guy wires as needed until the base tube is vertical ( $90^\circ \pm 0.5^\circ$ ).

It may take multiple adjustments from the bottom to the top of the tower before the tower is completely plumb. Starting with level 1 and working your way up the tower, have 2-3 technicians working at the front anchors utilizing Chicago grips and come-alongs to tension the guy wires.

First, set level #1 back guy tension to 60 lbf using the worm gear, then pull in on the #1 front guy wire to straighten the tower. As level #1 front guy wire is being tensioned, the scale measuring the back guy wire for level #1 will increase. Slowly feather the worm gear tension on the back guy wire to remain at 60 lbf while the front guy wire is tensioned. Once you achieve the desired tower location for level one. Lock down the front guy wire at the anchor point with the correct wire rope clips and re-tension the scale on the back guy wire to 100lbf.

You will notice that the levels above and sometimes below the one you are working on will increase their tension as you plumb the tower. Keep tensions at 150 lbf or below if they try to spike to higher tensions.

Move to level 2 and repeat the same process. It may be necessary to skip guy levels and work on a particular level that is too far out of alignment. You should always try to keep the tower as straight as possible while plumbing the tower.

When the tower is plumb, set up on the back anchors with a come-along and Chicago grip. One level at a time starting with level 1, pull in the slack on the back guy wire while letting out on the worm gear until the easy feed pulley is no longer holding the back guy wire. Remove pulley and fasten guy wire to anchor at the correct pulse method tension.

When the tower is plumb, all guywires shall be properly tensioned mechanically and tested using the pulse method for guy tension. See table 4-1 below for proper pulse method guy tensions.

Once the tower is plumb (within one-quarter ( $\frac{1}{4}$ ), 10" tube diameter over entire tower), make final adjustments to the guy wires so that they are properly tensioned (see section entitled *4.5.1 Guy Tension Check* for details).

#### **4.5.1 Guy Tension Check**

We recommend two (2) techniques outlined in ANSI/TIA-222-G to more accurately set guy wire tensions to ensure they are consistent and match well with the tensions assumed during the tower structural analysis. The two (2) methods described below are:



- Pulse Method
- Tangent Intercept Method



**PROPER GUY WIRE TENSION IS CRITICAL.** FAILURE TO ENSURE PROPER GUY WIRE TENSION CAN CAUSE A FAILURE OF THE TOWER, GUY WIRES OR GUY ANCHORS RESULTING IN SERIOUS INJURY, DEATH OR PROPERTY DAMAGE. ONCE LIFTED, ALWAYS READ AND FOLLOW INSTRUCTIONS FOR MEASURING AND REACHING PROPER GUY WIRE TENSION.

*Critical Installation Step: Guy Tension Measurement Methods*

When the tower is erect, you may use either the Tangent Intercept or Pulse Method, whichever you prefer.

During tower erection, use the Pulse Method to measure and adjust the tension in the Side Guy Wires.

**4.5.1.1 Pulse Method**

The pulse method is as follows:

- Apply a sharp jerk to the guy wire above its anchor point (just above the wire rope clips). You may need to lift up the guy guard to access the wire rope. The jerk to the guy wire will transmit a pulse along the wire (you can see the pulse visually, and, if holding loosely onto the wire rope, you can feel it in your hand when the pulse returns down the wire). Coincide with the applied jerk, start your stopwatch. Your stopwatch should be capable of measuring time to within a 1/10th of a second.
- Measure the time it takes the pulse to travel up and back down, twice (N = 2 pulses).
- Repeat the Pulse Method three (3) times and record the average value.
- Verify the average measured pulse time is within the allowable range as shown in
- Table 4-1: and Table 4-2
- If necessary, adjust the guy wire tension per the section entitled *Adjusting Guy Wires*.

**Table 4-1: Guy Tensioning per the Pulse Method (Tower Erect at 90°)**

Guy Level	N (# of pulses)	Minimum Time (sec)	Maximum Time (sec)
1 (Lower)	2	2.5	3.1
2	2	2.8	3.3
3	2	3.1	3.6
4	2	3.3	4.0
5	2	3.8	4.4
6	2	4.3	4.9



**Table 4-2: Guy Tensioning per the Pulse Method (During Tower Erection)**

Guy Level	N (# of pulses)	Minimum Time (sec)	Maximum Time (sec)
1 (Lower)	2	2.5	4.3
2	2	2.8	4.4
3	2	3.1	5.1
4	2	3.3	5.8
5	2	3.8	6.4
6	2	4.3	7.1

For ease of measuring and efficiency of checking the tension of all six (6) levels of guy wires during the lifting process. Measuring with the Pulse method using 1 pulse (N=1) is acceptable. The chart below shows in green the optimal tension that you want to achieve for each level during the tower erection. The seconds counted for a single pulse (up to the guy ring and back to your hand) should equal the seconds shown on the top line of the chart for each level.

**Table 4-3: Guy Tension for pulse method (during tower erection) N = 1.**

		During Tower Erection					
		Tension (lbf) for Pulse Times (seconds)					
Guy Level	N (# of pulses)	6	5	4	3	2	1
6 (top)	1	38	54	84	150	338	1352
5	1	31	44	69	123	276	1103
4	1	25	37	57	102	229	916
3	1	18	26	41	73	165	659
2	1	15	22	35	62	139	554
1 (Bottom)	1	14	20	31	55	123	491

Use Table 4-3 shown above for testing side guy wire tension during the tower lift. N=1 is the time that it takes for the pulse of the cable when hit with your hand to travel up to the guy ring at the tower and back to your hand. The time in seconds and tension highlighted in green is where each level should be during the entire tower erection. While the tower is being raised it is more efficient to use the N=1 method to confirm guy wire tension. Once the tower is vertical, all guy wires should be tensioned using the N=2 method shown above in Table 4-1.



#### 4.5.1.2 Tangent Intercept Method

The basis for the Tangent Intercept Method of verifying guy wire tensions is a visual “sighting” technique shown in Picture 4-6 and described below.

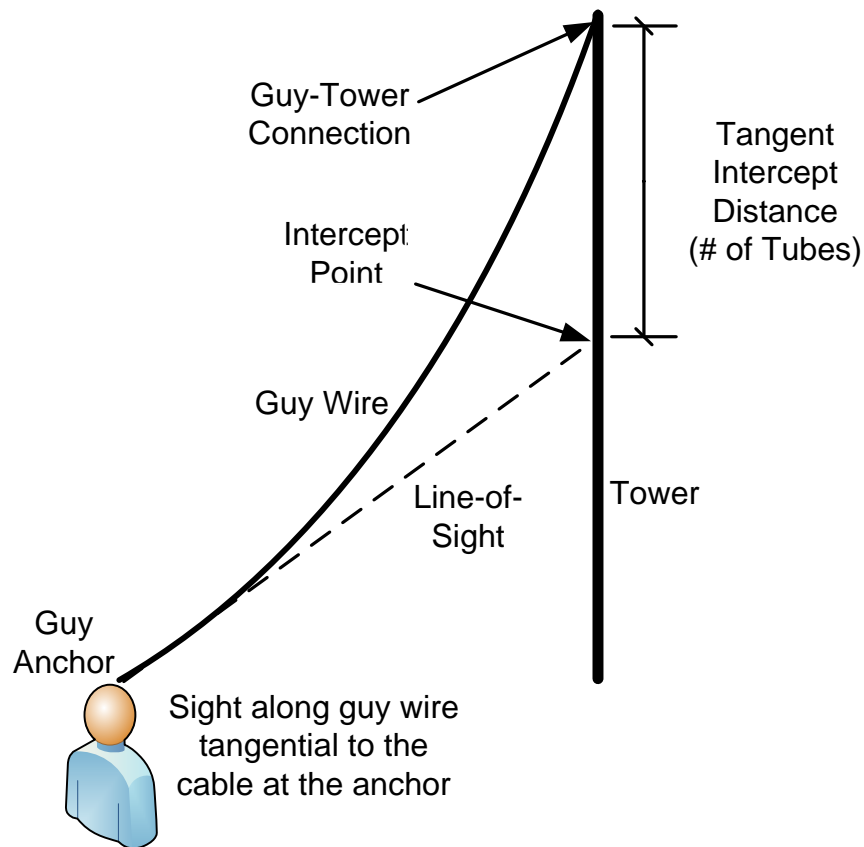

Picture 4-6: Tangent intercept method

Sight along the guy wire, tangential to the cable at the anchor point. Extend the line-of-sight until it intersects the tower. The tangent intercept is the distance between the guy-tower connection and the intersection of the line-of-sight with the tower. This tangent intercept distance is measured in terms of the number of tower tubes and is directly related to the guy wire tension.

As an example, Picture 4-7 shows a view of the Level 1 guy wire from near the ground up toward the guy ring. If you look closely, you will note that the projected line of the lower portion of the guy intersects the tower at about one tower tube below the Level 1 guy ring (visible just above the ribbon). This represents a “guy sag” of “1-1/4 tubes”. Picture 4-8 shows the same guy wire somewhat looser. In this case, the guy wire appears to intersect about 2-½ tower tubes below the guy ring (guy sag = 2.5 tubes).



**Picture 4-7: Level 1 guy, sag = 1-1/4 tube - just right**



**Picture 4-8: Level 1, guy sag = 2.5 tubes - too loose**

Using this sighting technique, adjust guy tensions to fit within the limits shown in Table 4-4 or Table 4-5 below.

**Table 4-4: Guy Tensioning per the Tangent Intercept Method (Tower Erect at 90°)**

Guy Level	Guy Slack Range (# of Tubes below Guy Ring)	
	Least Sag	Most Sag
1 (Lower)	1	1 1/2
2	1 1/4	1 3/4
3	1 1/2	2
4	1 3/4	2 1/2
5	2 1/4	3
6 (Including transition as one tube)	3 1/4	4

As an example, for Level 1, the least sag the guy wire should have is 1 tube; the most sag is 1 1/2 tubes. Therefore, the guy wire in Picture 4-7 (sag = 1-1/4 tubes) meets the requirement, but the guy wire in Picture 4-8 above (guy sag = 2.5 tubes) is too loose.



**Table 4-5: Guy Tensioning per the Tangent Intercept Method (During Tower Erection)**

Guy Level	Guy Slack Range (# of Tubes below Guy Ring)	
	Least Sag	Most Sag
1 (Lower)	1	3
2	1 ¼	3
3	1 ½	4
4	1 ¾	5
5	2 ¼	6
6 (Including transition as one tube)	3 ¼	7

#### 4.6 TRANSFER LIFTERS

Transfer the lifting guy wires one at a time from the ginpole to the spare 8 inch diameter screw-in anchor located approximately 5 meters (15 feet) from the tower baseplate, in close proximity to the ginpole.

Prepare the 8 inch screw-in anchor by attaching two large medium duty thimbles, as shown in Picture 4-9. The thimbles are attached to the 8 inch anchor using a short-run of 5/6 inch diameter wire rope and three (3) 5/16" wire rope clips.

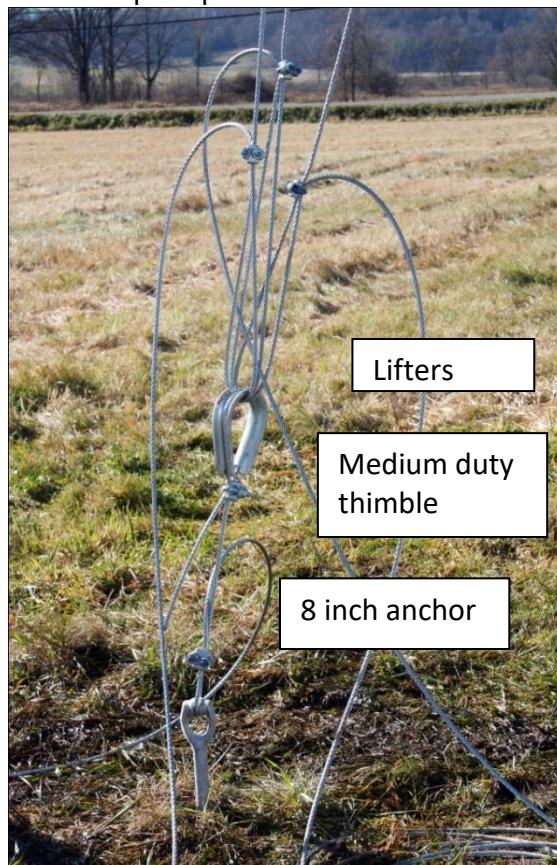

**Picture 4-9: Lifter storage**

Once the thimbles are in place, transfer the lifters one-at-a-time, starting with level #1. To remove the lifter from the ginpole, clip the Chicago Grip and come-along to the lifter



approximately 1 m (3 feet) above the rocker plate. Wrap a sling around the tip of the ginpole and secure the free end of the come-along to the sling, as shown in picture4-10 below.



**Picture 4-10: Set up for transferring lifters to their storage anchor**

Pull tension using the come-along until the lifter goes slack. Loosen and remove the bolt/nut that attaches the lifter. Reverse direction on the come-along, un-clip the Chicago Grip and hand transfer the lifter over to the stationary thimble for storage. Clip another Chicago Grip and come-along to the lifter approximately 2 meters (6 feet) above the thimble, as shown below.



**Picture 4-11: Using a Chicago grip**





Affix the free end of the come-along to the 8 inch anchor using a  $\frac{3}{4}$ " shackle attached to the shank of the anchor. Pull tension in the lifter using the come-along until the slack in the lifter has been removed. Weave the lifter through the thimble and secure using three (3)  $\frac{5}{16}$ " wire rope clips, as shown in Picture 4-12.



**Picture 4-12: Fastening your lifter to the storage anchor**

Reverse the come-along until the load has been transferred to the stored lifter. Remove the come-along and Chicago grip, and proceed onto the next lifter. Lifters #1 through #4 attach to one of the storage thimbles; lifters #5 through #8 attach to the second thimble. Picture 4-13 below shows the storage of the lifters and the proper tension you will want to achieve.



**Picture 4-13: Lifter storage**

On the last lifter, #6 (top) lifter, you will be releasing the thimble from the rocker plate at the end of the ginpole, then utilizing the come-along to lower the ginpole all the way to the ground. It is helpful to block under the jumper struts in order to support the ginpole when it reaches the ground.

#### **4.7 FINAL INSPECTION AND MAINTENANCE**

Tighten all wire rope clips on each guy wire, allowing approximately 100 mm to 200 mm (4 inches to 8 inches) between clips. Final torque on wire rope clips should be as listed in Table 4-6: below.

**Table 4-6: Wire Rope Clip Torque Values**

Wire rope clip size (inches)	Torque Wrench N-m (ft-lbf)
3/16	10 (7.5)
5/16	41 (30)
3/8	61 (45)

The ginpole may be left in place, or it may be removed and disassembled, if desired. If using guy guards, attach one to each guy wire as well as the ginpole lateral guy wires.

Guy guards may be necessary in areas:

- Where snow is prevalent
- Grazing animals are present
- Field mowing will be necessary



**Picture 4-14: Guy guards**

Check the tower in 2 or 3 weeks; tighten loose guys and straighten the tower if needed. It is especially important to do this before any icing events occur. Also check the guy wires after any severe ice or wind storm. Some settling of the tower or anchors may occur, and guy wires can stretch. Loose guy wires can also result when the wire rope clips securing the guys are forced down by the impact of sliding ice.



One of the most important reasons for good tower maintenance, particularly guy tension maintenance, is to avoid a form of tower failure known as “Snap-Through.” Snap-Through typically occurs when the guys are allowed to become loose, and a high wind is blowing on the tower. Even in normal conditions, the upper guys work at a narrower angle to the upper tower than the lower guys, reducing their effectiveness at restraining sideways bending (see Picture 4-15: Snap-through). If the guys are allowed to become loose, the working angle is further decreased. If the loads are high enough, or the guys are too loose, the angle between the guy and the tower will reduce to zero, and the guy can no longer restrain the sideways motion. The result is that the upper tower “snaps through” and falls over.

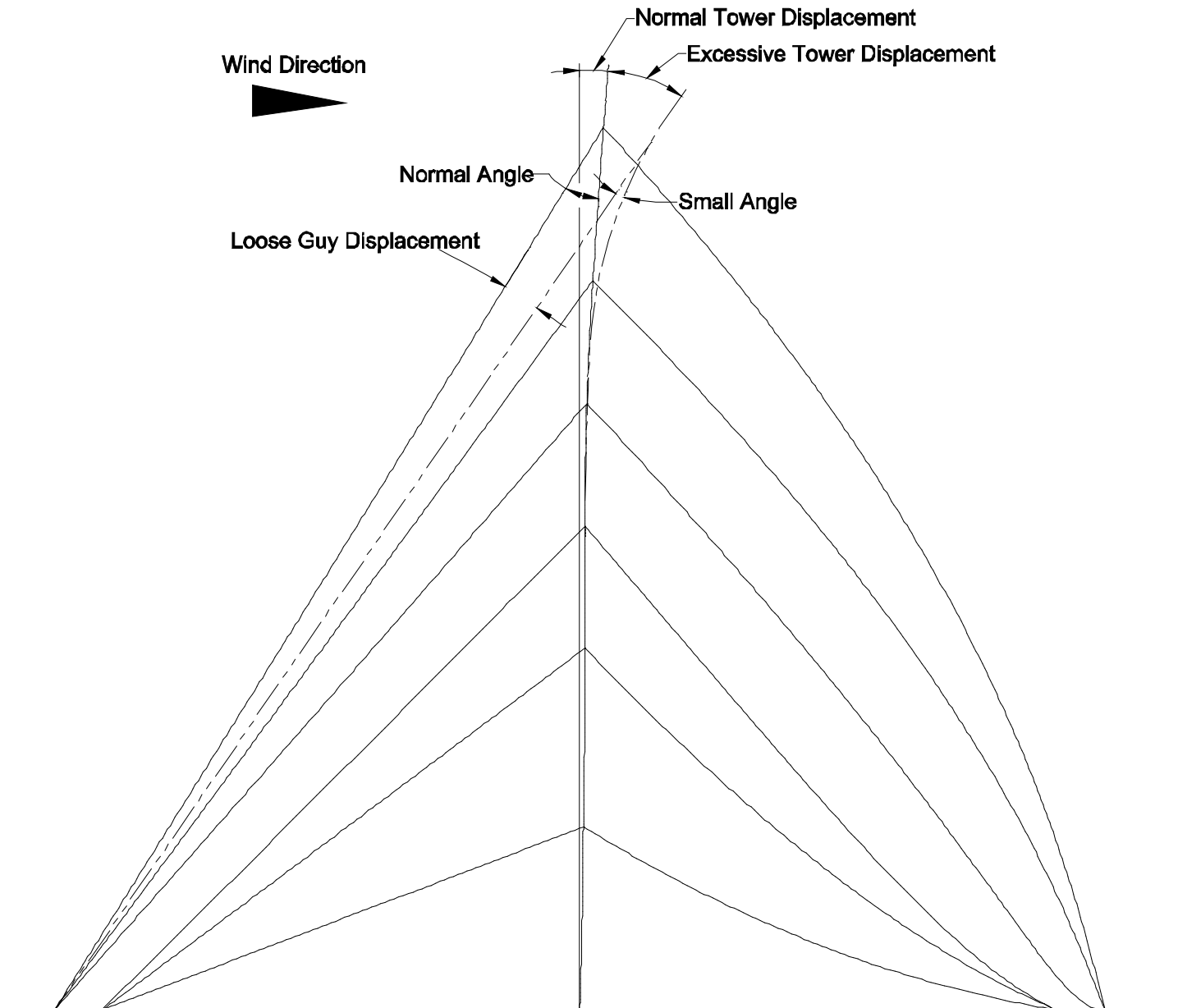

Picture 4-15: Snap-through diagram



**MAINTAINING PROPER GUY WIRE TENSION IS CRITICAL.** FAILURE TO MAINTAIN PROPER GUY WIRE TENSION AFTER INSTALLATION CAN CAUSE A FAILURE OF THE TOWER, GUY WIRES OR GUY ANCHORS RESULTING IN SERIOUS INJURY, DEATH OR PROPERTY DAMAGE. AFTER INSTALLATION, IT IS IMPORTANT TO CHECK GUY WIRE TENSION PERIODICALLY AND ENSURE PROPER TENSION MEASUREMENTS ARE MAINTAINED. ALWAYS READ AND FOLLOW INSTRUCTIONS FOR MAINTAINING PROPER GUY WIRE TENSION.

## Chapter 5: Tower Lowering

### 5.1 TOWER LOWERING OVERVIEW

Lowering the tower is the reverse of raising the tower, though there are differences between the methods and a few additional precautions. As with lifting, tower lowering consists of three (3) distinct phases:

- Tower Lowering from 90° to 80 (Max tension on back stay tensioning system = 150 lbf.)
- Tower Lowering from 80° to 60° (Max tension on back stay tensioning system = 200 lbf.)
- Tower Lowering from 60° to 0°

Each of the phases of tower lowering is described below.

#### 5.1.1 Critical Installation Step: Tensioning the ginpole jumper strut cables

If the ginpole was removed, set-up the ginpole as described in the section entitled *Ginpole*. Make sure the ginpole jumper strut cables are properly tensioned.



**MAINTAINING PROPER GINPOLE JUMPER STRUT CABLE TENSION DURING LOWERING IS CRITICAL.** FAILURE TO MAINTAIN PROPER GINPOLE JUMPER STRUT CABLE TENSION DURING LOWERING CASE CAUSE THE GINPOLE TO BEND OR COLLAPSE RESULTING IN SERIOUS INJURY, DEATH OR PROPERTY DAMAGE. IT IS THEREFORE IMPORTANT TO CHECK AND MAINTAIN TENSION ON THE GINPOLE JUMPER STRUT CABLE. ALWAYS READ AND FOLLOW INSTRUCTIONS FOR MAINTAINING PROPER TENSION.



### 5.1.2 Critical Installation Procedure: Utilize the Back Stay Tensioning System

#### 5.1.3 Phase 1: Tower Lowering from 90° to 60° (Max tension on back stay tensioning system = 150 lbf.)

For the tower lowering between 90° and 80°, it is imperative the Back Stay Tensioning System is used to incrementally lower the tower. The Back Stay Tensioning System ensures tension exists on the back guy wires at all times during the lowering when the tower is between 90° and 80°. Failure to provide sufficient tension on the back guy wires (e.g., not using the Back Stay Tensioning System) may result in the tower deforming or buckling.

All terrain slopes suitable for a Super 60m tower also require the use of the Back Stay Tensioning System.

## NOTICE

**ALWAYS MAINTAIN PROPER TENSION ON GUY WIRES DURING THE LOWERING PROCESS, ESPECIALLY WHEN THE TOWER IS BETWEEN 90° AND 60°.** FAILURE TO MAINTAIN PROPER GUY WIRE TENSION CAN CAUSE DEFORMATION OR OTHER DAMAGE TO THE TOWER. ALWAYS READ AND FOLLOW LOWERING INSTRUCTIONS FOR INCREMENTAL LOWERING AND CAREFULLY UTILIZE THE BACK STAY TENSIONING SYSTEM METHOD SET FORTH IN THE INSTALLATION MANUAL.

If the tower will be lowered onto blocking, place the blocking now while it is still safe to work under the tower.

Remove the upper level lifter from the storage thimble and walk it over to the ginpole. Attach a sling to the end of the ginpole. To the lifter, attach a Chicago Grip and come-along approximately 1 m (3 feet) from the thimble. Attach the free end of the come-along to the sling and lift the ginpole. Affix the lifter to the rocker plate on the ginpole. Repeat the transfer process for the remaining lifters.

Disconnect the front guys, starting with Level 1 and working up to Level 8.

With the tower vertical at 90°, apply 150 lbf to all six (6) of the back guy wires utilizing the back stay tensioning system. See [Appendix E](#) for full procedure.

In incremental lowering steps, lower to the point where the one of the levels reaches the minimum tension stated for each level in the back stay tensioning system. Stop the lift and tension all six (6) levels back to 150 lbf. Continue this method until you reach 80 degrees.

#### 5.1.3 Tower Lowering from 80° to 60°



Continue the incremental lowering technique similar to phase 1. The maximum tension that can be placed on all 6 levels of back guy wires is 200 lbf. Start your lowering with scales at 200 lbf, then lower until one of the levels reaches the minimum tension level. Stop the lift and re-tension all six (6) levels to 200 lbf.

As the tower is lowered and reaches an angle of 60°, it is no longer necessary to maintain manual tension on the back guy wires. The Back Stay Tensioning system can be left where it is until the tower is on the ground.

#### **5.1.4 PHASE 2: TOWER LOWERING FROM 60° TO 0°**

Continue lowering the tower by letting out the winch cable.

Stop the winch at least every 20 degrees to re-check side-guy wire tension. Refer to the sections entitled [Guy Tension Check and Adjusting Guy Wires](#) for instructions on measuring and adjusting guy tension.

It is critical to keep the tower straight at all times. This is particularly important when the tower is near the ground where forces are at their greatest and most difficult to control.

The force on the winch is greatest as the tower nears the ground. Be sure to stand to either side of the winch cable, rather than directly in line with it. To lower the ginpole, put the helper ginpole in place before the ginpole reaches 45°. As the ginpole nears the ground, place the winch cable (all five (5) strands) into the 5 V-belt pulleys on the top of the helper ginpole. You will need the use of a 3 meter (10 foot) ladder to access the V-belt pulleys. The pole can then be lowered to the ground.

## Appendix A: Super 60 m XHD TallTower with Standard Footprint Tower Layout

TUBE SPECS (in order of assembly):

Tower:  
Base Tube (with pivot pin hole) 10"  $\phi$  x 87'L (1 tube)  
Plain Tubes 10"  $\phi$  x 87'L (28 tubes)  
10" - 8" Transition, 36'L  
Plain Tubes 8"  $\phi$  x 87'L (2 tubes)

Gin Pole:  
Base Tube (with pivot pin hole) 10"  $\phi$  x 87'L (1 tube)  
Plain Tubes 10"  $\phi$  x 87'L (8 tubes)  
Top Tube 10"  $\phi$  x 87'L (1 tube)

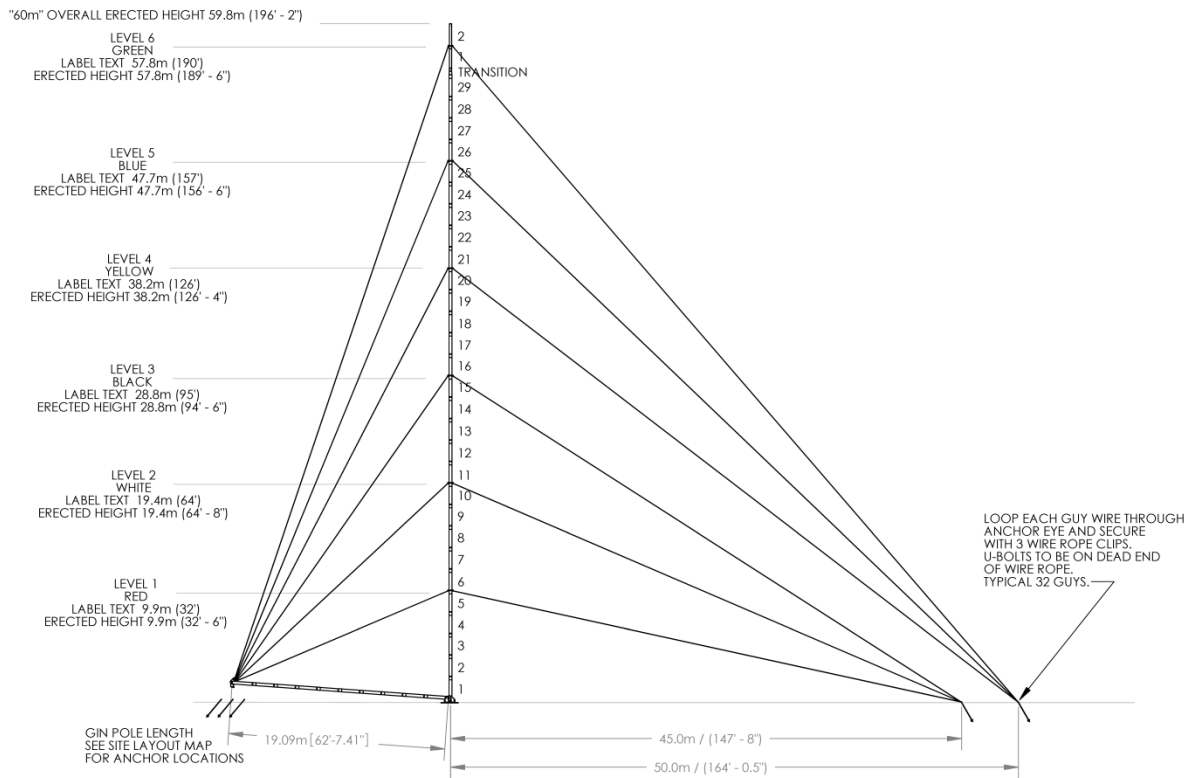

Picture A-1: Super 60 m XHD TallTower Layout



SITE LAYOUT

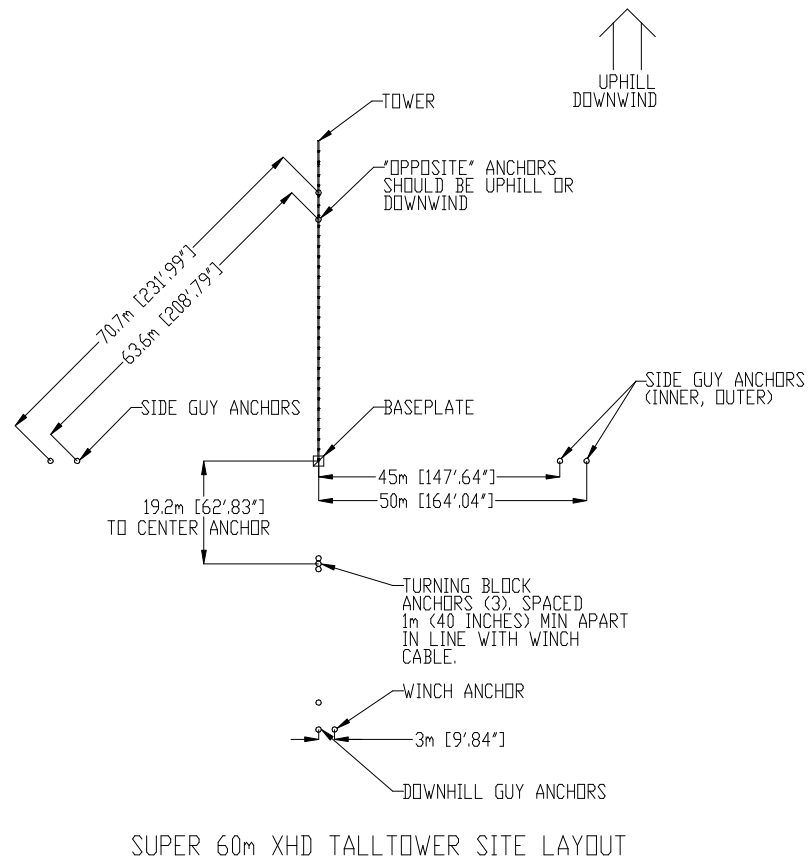

Picture A-2: Super 60m Site Layout

**TABLE A-1: TOWER ERECTION FORCES (TOWER ONLY)**

ANSI/TIA-222-G wind velocity	Horizontal base reaction	Winch anchor reaction (b)
0 m/s (0 mph)	28.9 kN (6500 lbs.) (a)	40.0 kN (9000 lbs) @ 44° from Horizontal (c) Load spread between the 4 anchors Maximum load per anchor 16.0 kN (3600 lbs)

**TABLE A-2 TOWER ERECTION FORCES (WITH TYPICAL NOW SYSTEM – 3 BOOMS AT 30 M, 3 BOOMS AT 40 M, 3 BOOMS AT 58 M)**

ANSI/TIA-222-G wind velocity	Horizontal base reaction	Winch anchor reaction (b)
0 m/s (0 mph)	30.4 kN (6830 lbs.) (a)	42.3 kN (9500 lbs) @ 44° from Horizontal (c) Load spread between the 4 anchors Maximum load per anchor 16.9 kN (3800 lbs)

**Notes:**

The maximum horizontal reaction occurs when the tower is just off the ground.

Maximum force on the winch anchor during tower erection (occurs when tower is just above the ground).

Orientation view defining angle shown in Picture A-3.

The reported tower erection forces do not assume any factor of safety.

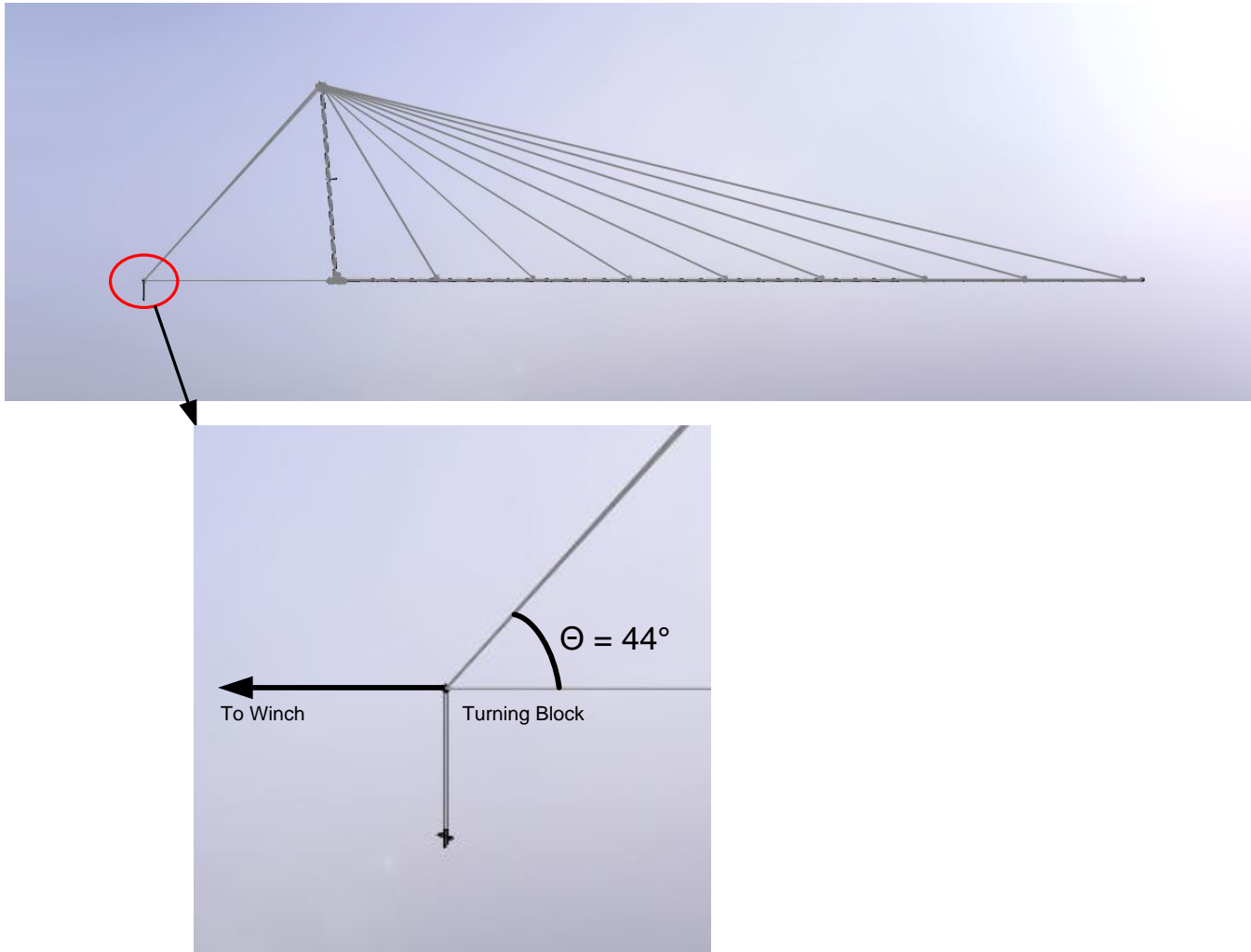

Picture A-3: Angle of winch cable at maximum load

## **ANSI/TIA-222-G Compliance Limits, Maximum Anchor Loads, and Baseplate Loads**

The following graphs allow you to verify your tower meets ANSI/TIA-222-G requirements. Reactions and member forces apply to a Super 60 m XHD TallTower equipped with galvanized steel wire rope per Federal Specification RR-W-410F.

To use the graphs, you will need to obtain wind and wind with ice load requirements. ANSI/TIA-222-G Annex B lists design criteria for U.S. counties and its territories. You should also confirm the design criteria with your local permitting agency.

Using wind and wind with ice design values, find the point at which they intersect on graphs shown in Picture A-4 or A-5 below and verify that this point is within the recommended operating zone. Maximum anchor loads and baseplate loads are obtainable using Pictures A-6 through A-9 below.

Consideration for unusual winds and winds with ice must be given to mountainous terrain and gorges.

Please note that these graphs are based on the 3-second gust definition of wind speed per ANSI/TIA-222-G.

Code Compliance Curve – Imperial Units

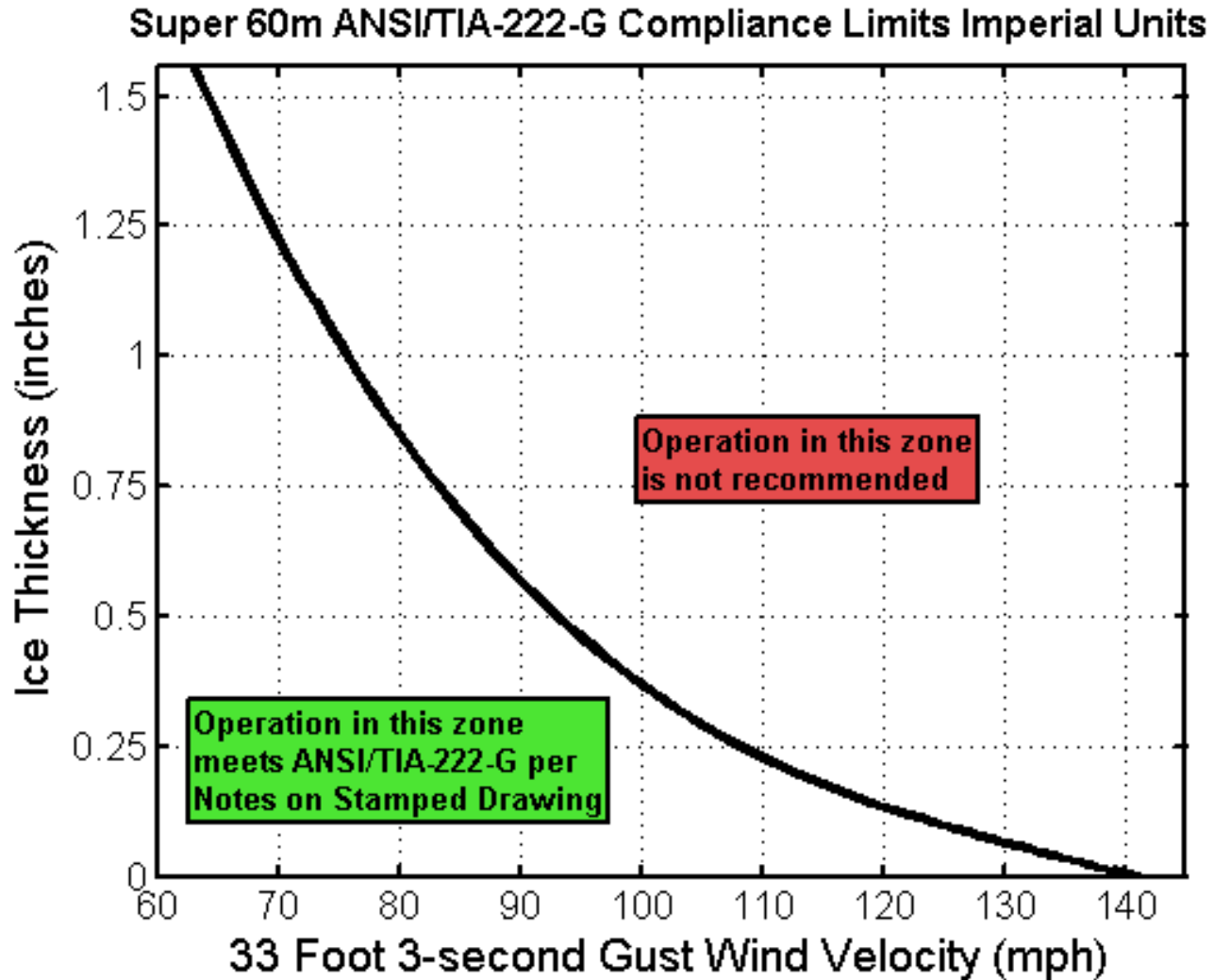

Picture A-4: Super 60m ANSI/TIA-222-G Compliance Limits Imperial Units

CODE COMPLIANCE CURVE – SI UNITS

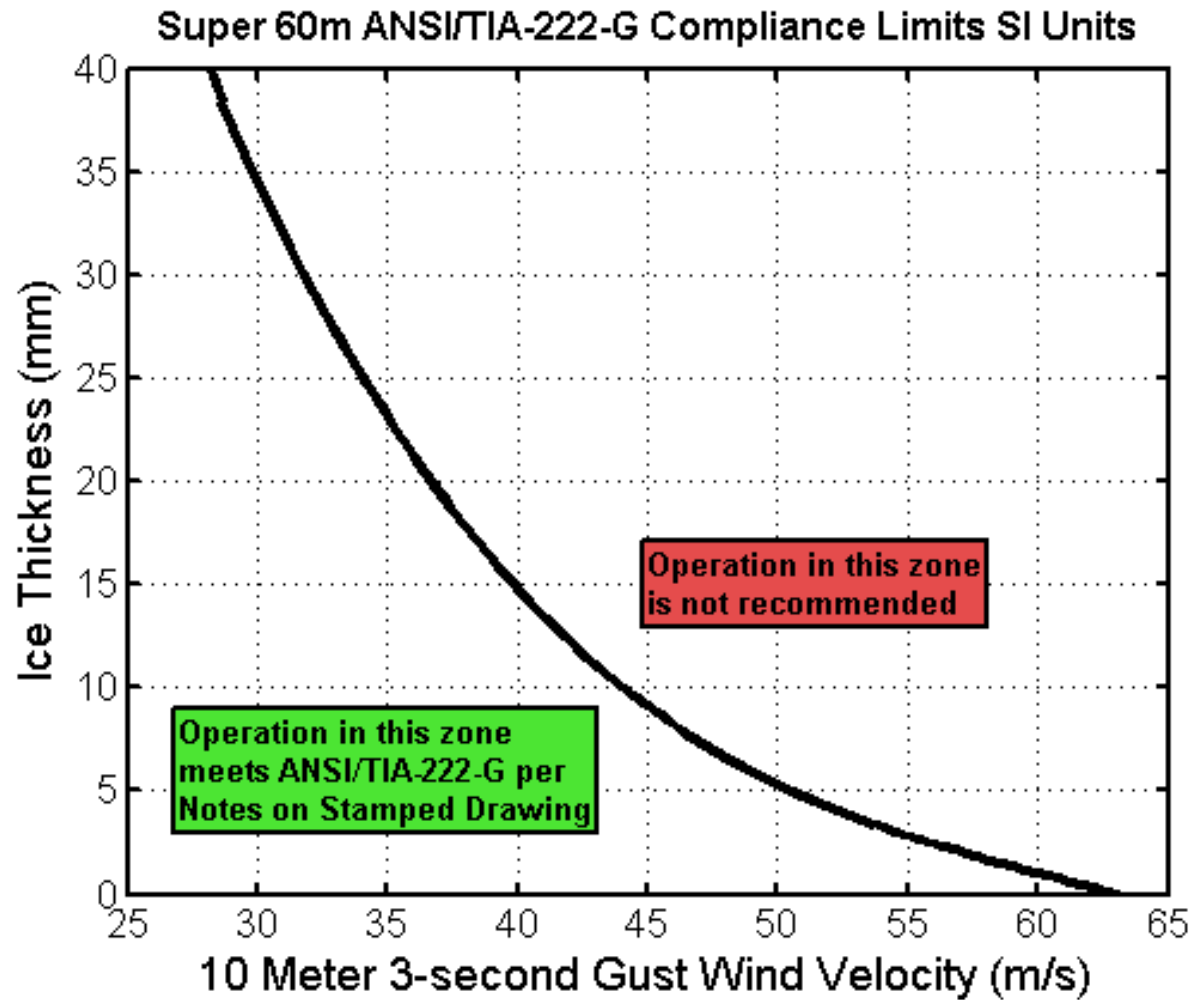

Picture A-5: Super 60 m XHD TallTower ANSI/TIA-222-G Compliance Limits SI Units

# Super 60m with Standard Footprint

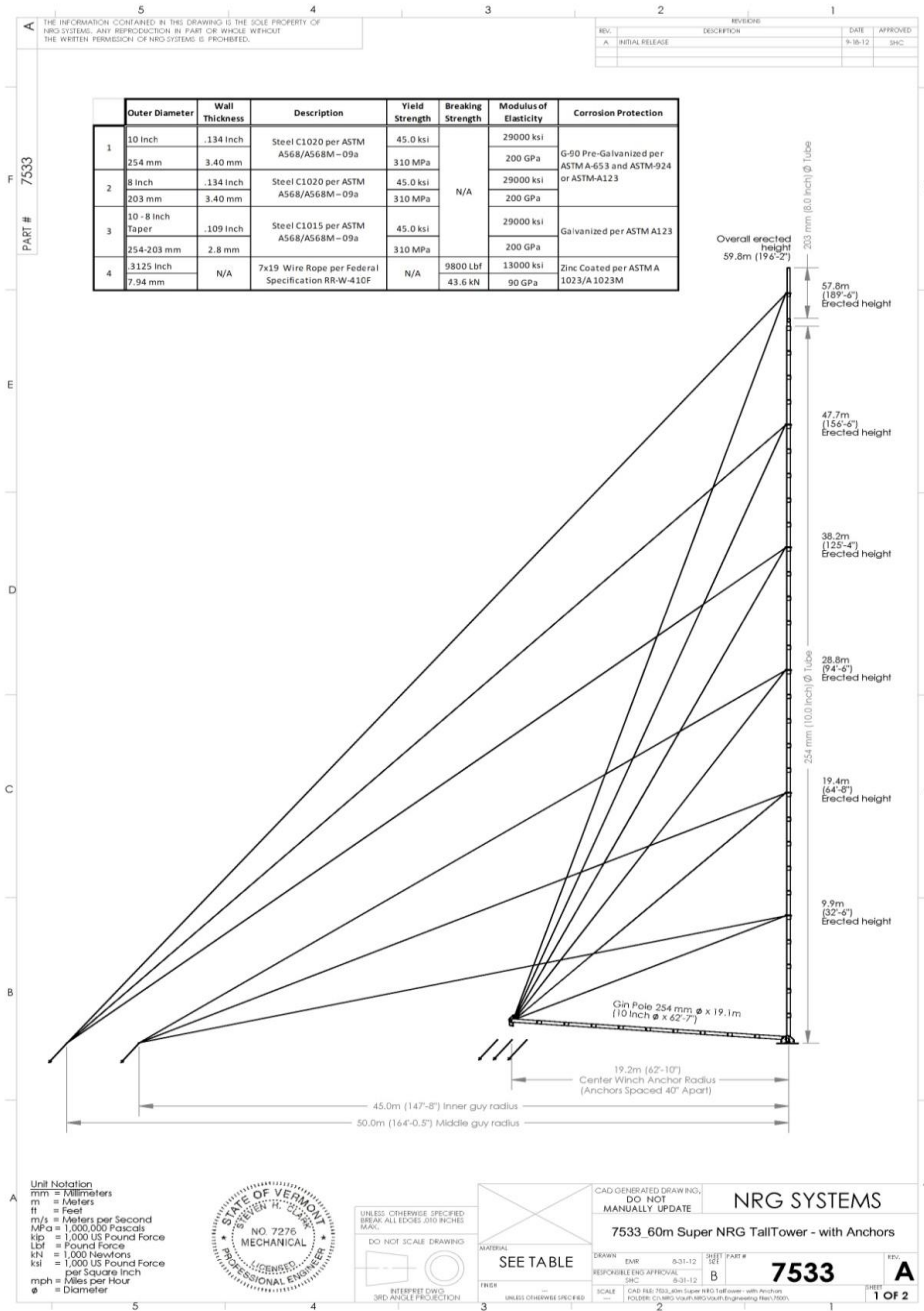

Super60m\_X

# Super 60m with Standard Footprint

THE INFORMATION CONTAINED IN THIS DRAWING IS THE SOLE PROPERTY OF NRG SYSTEMS. ANY REPRODUCTION IN PART OR WHOLE WITHOUT THE WRITTEN PERMISSION OF NRG SYSTEMS IS PROHIBITED.

	Reactions and Member Forces																	
	No Ice		6.4mm (0.25 in) Ice			12.7mm (0.5 in) Ice			19mm (0.75 in) Ice			25mm (1 in) Ice			40mm (1.6 in) Ice			
	Imperial	SI	Imperial	SI	Imperial	SI	Imperial	SI	Imperial	SI	Imperial	SI	Imperial	SI	Imperial	SI		
10m (33 feet) Wind Velocity (3-second gust)	141 mph	63.0 m/s	108 mph	48.3 m/s	93 mph	41.6 m/s	84 mph	37.6 m/s	75 mph	33.5 m/s	63 mph	28.2 m/s						
Top of Tower Wind Velocity (3-second gust)	205 mph	91.6 m/s	157 mph	70.2 m/s	137 mph	61.2 m/s	122 mph	54.5 m/s	109 mph	48.7 m/s	92 mph	41.1 m/s						
Inner Guy Anchor Force	6.3 kip	28.0 kN	5.9 kip	26.2 kN	5.9 kip	26.2 kN	6.2 kip	27.6 kN	6.4 kip	28.5 kN	8.3 kip	36.9 kN						
Angle from Horizontal	23 degrees		22 degrees		31 degrees		20 degrees		18 degrees		15 degrees							
Outer Guy Anchor Force (Notes 4, 5)	<b>12.5</b> kip	<b>55.6</b> kN	<b>12.3</b> kip	<b>54.7</b> kN	<b>12.3</b> kip	<b>54.7</b> kN	12.3 kip	54.7 kN	12.3 kip	54.7 kN	11.4 kip	50.7 kN	11.3 kip	50.3 kN				
Angle from Horizontal	41 degrees		41 degrees		40 degrees		40 degrees		39 degrees		36 degrees							
Tower Base Down Thrust	30.0 kip	133.4 kN	31.7 kip	140.9 kN	35.1 kip	156.1 kN	39.0 kip	173.6 kN	41.9 kip	186.5 kN	54.4 kip	241.9 kN						
Tower Base Shear	0.129 kip	0.6 kN	0.152 kip	0.7 kN	0.144 kip	0.6 kN	0.133 kip	0.6 kN	0.223 kip	1.0 kN	0.587 kip	2.6 kN						
Tower Base Torque (due to stored lifting guys)	6.0 kip-in	0.68 kN-m	6.6 kip-in	0.7 kN-m	7.8 kip-in	0.9 kN-m	8.8 kip-in	0.99 kN-m	8.9 kip-in	1.01 kN-m	9.2 kip-in	1.04 kN-m						
Winch Anchor Load (Note 10) (during erection)	9.0 kip	40.0 kN																
Angle from Horizontal	44 degrees		44 degrees															
Tower Base Shear (Note 10) (during erection)	6.5 kip	28.9 kN																
Initial Guy Tension	0.255 kip	1.13 kN																
7.9mm (0.313 in) Diameter																		
Maximum Guy Tension	4.5 kip	20.0 kN	4.6 kip	20.5 kN	4.9 kip	22.0 kN	<b>5.3</b> kip	<b>23.5</b> kN	<b>5.2</b> kip	<b>23.1</b> kN	<b>5.2</b> kip	<b>23.0</b> kN						
7.9mm (0.313 in) Diameter (Note 5)																		
Maximum Tower Deflection	36.1 in	918 mm	37.3 in	947 mm	38.8 in	987 mm	40.1 in	1019 mm	37.4 in	949 mm	32.6 in	829 mm						
Maximum Combined Stress Ratio (CSR) in 203mm (8 in) Diameter Tube (Note 5)	0.230	Section No. L2	0.218	Section No. L2	0.199	Section No. L2	0.199	Section No. L2	0.187	Section No. L2	0.202	Section No. L2						
Moment	54 kip-in	6.1 kN-m	49 kip-in	5.6 kN-m	41 kip-in	4.6 kN-m	39 kip-in	4.4 kN-m	34 kip-in	3.8 kN-m	34 kip-in	3.9 kN-m						
Axial Load	8.1 kip	36 kN	8.5 kip	38 kN	9.4 kip	42 kN	10.3 kip	46 kN	10.8 kip	48 kN	12.8 kip	57 kN						
Maximum Combined Stress Ratio (CSR) in Transition 254mm (10 in) - 203mm (8 in) Diameter Tube (Note 5)	0.228	Section No. L3	0.215	Section No. L3	0.195	Section No. L3	0.194	Section No. L3	0.181	Section No. L3	0.195	Section No. L3						
Moment	59 kip-in	6.7 kN-m	54 kip-in	6.1 kN-m	44 kip-in	5.0 kN-m	42 kip-in	4.7 kN-m	36 kip-in	4.1 kN-m	36 kip-in	4.0 kN-m						
Axial Load	8.1 kip	36 kN	8.5 kip	38 kN	9.5 kip	42 kN	10.3 kip	46 kN	10.9 kip	48 kN	12.9 kip	57 kN						
Maximum Combined Stress Ratio (CSR) in 254mm (10 in) Diameter Tube (Note 5)	0.343	Section No. L30	0.342	Section No. L30	0.366	Section No. L30	0.418	Section No. L30	0.437	Section No. L30	0.644	Section No. L30						
Moment	76 kip-in	8.6 kN-m	70 kip-in	7.9 kN-m	73 kip-in	8.3 kN-m	87 kip-in	9.8 kN-m	89 kip-in	10.0 kN-m	147 kip-in	16.6 kN-m						
Axial Load	29.8 kip	132 kN	31.3 kip	139 kN	34.0 kip	151 kN	37.6 kip	167 kN	40.2 kip	179 kN	53.6 kip	238 kN						

Notes:

- Wind forces and member loads are calculated using ANSI/TIA-EIA-222-G-2 (2009) "Structural Standards for Antenna Supporting Structures and Antennas".
- Wind speeds are defined as the 3-second gust at 10 m (33 ft) above ground level per ANSI/TIA-222-G-2.
- ANSI/TIA-222-G-2 wind and ice load factors are included in the following table. For wind with ice load cases, the ice thickness with height is assumed constant (no ice escalation). The limit state conversion for ice thickness (2.0) per ANSI/TIA-222-G-2.2.6.8 is omitted.

Load Case	Classification of Structure	Wind Direction Probability Factor (K <sub>d</sub> )	Importance Factor (I)	Exposure Category	Velocity Pressure Coefficient (K <sub>z</sub> )			Topographic Category	Topographic Factor (K <sub>g</sub> )	Gust Effect Factor (G <sub>f</sub> )	Design Ice Thickness
					Z <sub>e</sub>	α	K <sub>z, min</sub>				
Wind without ice	I	0.95	0.87	C				1	1	1.10	N/A
Wind with ice	I	0.95	1.0	C	274 m (900 ft)	9.5	0.85	1	1	1.10	Constant ice thickness with tower height - no ice escalation with height. The limit state conversion for ice thickness (2.0) per ANSI/TIA-222-G-2.2.6.8 is omitted.

4. Maximum wind load reduced (for bold-face marked load cases) to maintain anchor loads below 55.6 kN (12.5 kip). Maintaining maximum anchor loads below 55.6 kN (12.5 kip) ensures a resistance factor of 1.2 provided anchors are pull tested to 66.7 kN (15 kip).

REV.	DESCRIPTION	DATE	APPROVED
SEE SHEET 1			

Notes (continued):

- Member forces and reactions are calculated using TrxTower by Tower Numerics (Version 6.0), a three-dimensional elastic beam-column finite element analysis (FEA) program that accounts for second-order effects. The effective yield stress is computed using TrxTower per Equation 4.5.4.1 (for axial compression) and 4.7.2 (for bending) of ANSI/TIA-222-G-2. The Combined Stress Ratio (CSR) is determined using TrxTower per Equation 4.8.2 of ANSI/TIA-222-G-2. The maximum CSR and Section No. in which it occurs is listed for 203mm (8 in) diameter tube, the transition, and 254mm (10 in) diameter tube. The corresponding moment and axial load is listed for each section. The reaction, member force, or CSR limiting the wind and wind with ice input load is emphasized using large boldface font for each load condition.
- This tower design meets the requirements of ANSI/TIA-222-G-2 for the given loading conditions, with exceptions. Contact NRG Systems, Inc. for more information.
- The baseplate ground surface area is 19.5 ft<sup>2</sup>. The baseplate cross-sectional area is sized to ensure the factored resistance of Clay soil (as defined in Annex F of ANSI/TIA-222-G-2) is greater than the reactions from the factored load combinations listed in section 2.3.2 of ANSI/TIA-222-G-2. The presumptive soil parameters per ANSI/TIA-222-G-2 assume dry soil conditions. If your soil can develop a significant ice lens (due to poor soil drainage) during freezing, it may be necessary to provide a foundation to ensure adequate bearing strength. In this case, foundation design must be considered separately and is not a part of this analysis. Foundation details must be approved for the specific application and site by a qualified professional.
- A locally qualified professional must determine the applicability of this analysis for the expected site conditions. Due to the lack of involvement in the siting or construction phase of this product at a specific location, liability is strictly limited to issues arising from negligence or willful misconduct by NRG or the professional engineer completing this analysis. No warranty, expressed or implied, is made concerning the suitability of this product for a given application or location.
- Given dimensions are nominal. Actual dimensions may vary.
- Erection forces are at zero wind speed on a flat terrain site and do not include tower appurtenances such as booms and obstruction marking lighting. The lifting guys are modeled as discrete appurtenances. The Winch Anchor Load is the summation of the four (4) winch anchor loads. Therefore, the Winch Anchor Load is spread between the four (4) anchors such that the maximum load per anchor is 16.0 kN (3600 lbf) during erection of a bare tower on flat terrain site.

DO NOT SCALE DRAWING

INTERPRET W/C 3RD ANGLE PROJECTION

CAD GENERATED DRAWING. DO NOT MANUALLY UPDATE

NRG SYSTEMS

7533\_60m Super NRG TallTower - with Anchors

DRAWN: EAW 8/31/12 SHEET PART # **7533** REV **A**

RESPONSIBLE ENG APPROVAL: SHC 8/31/12 **B**

SCALE: --- CAD FILE: 7533\_60m Super NRG TallTower - with Anchors 8/31/12 PLOTTED: CLM/C/04/14/2022/09:09:09 Engineering Team, 7533

SHEET **2** OF **2**



**ANCHOR LOADS – IMPERIAL UNITS (THE LOADS SHOWN ON THE GRAPH APPLY TO EACH OF THE ANCHORS)**

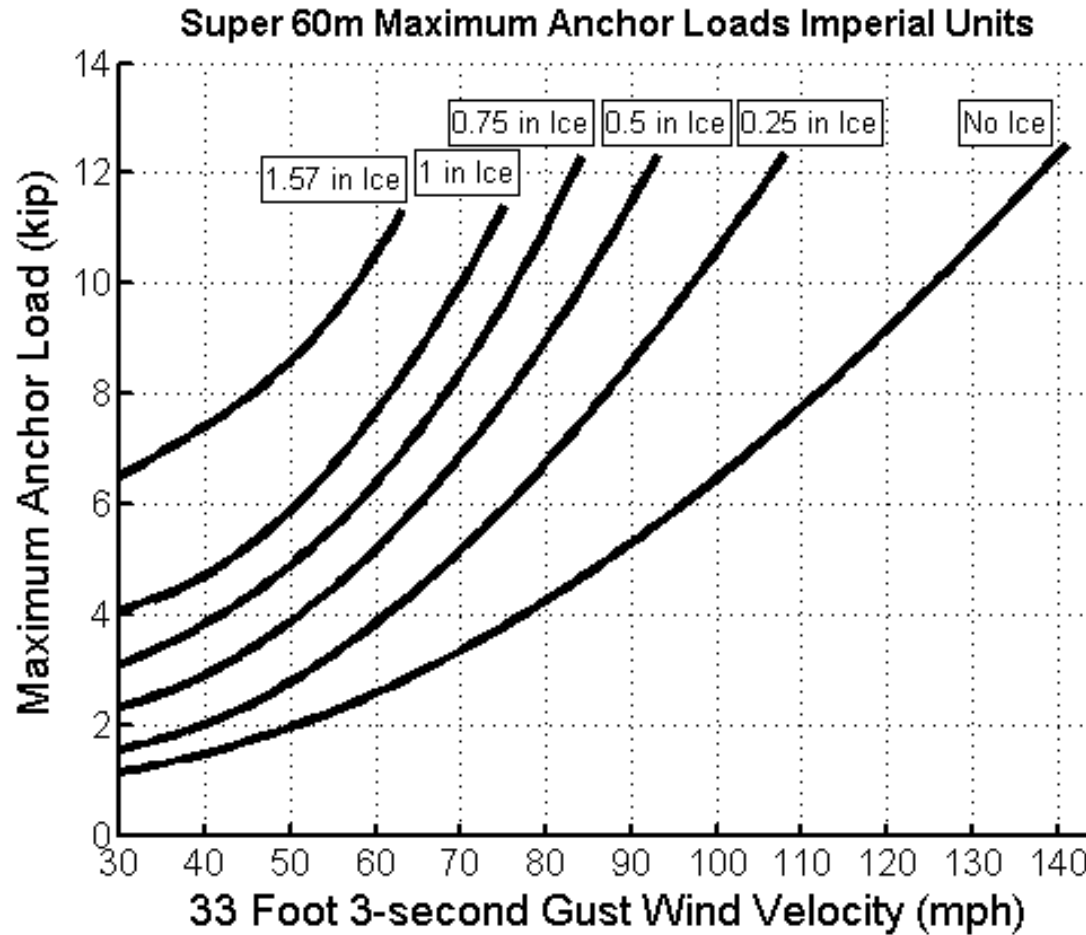

Picture A-6: Super 60 m XHD Maximum Anchor Loads Imperial Units

ANCHOR LOADS - SI UNITS (THE LOADS SHOWN ON THE GRAPH APPLY TO EACH OF THE ANCHORS)

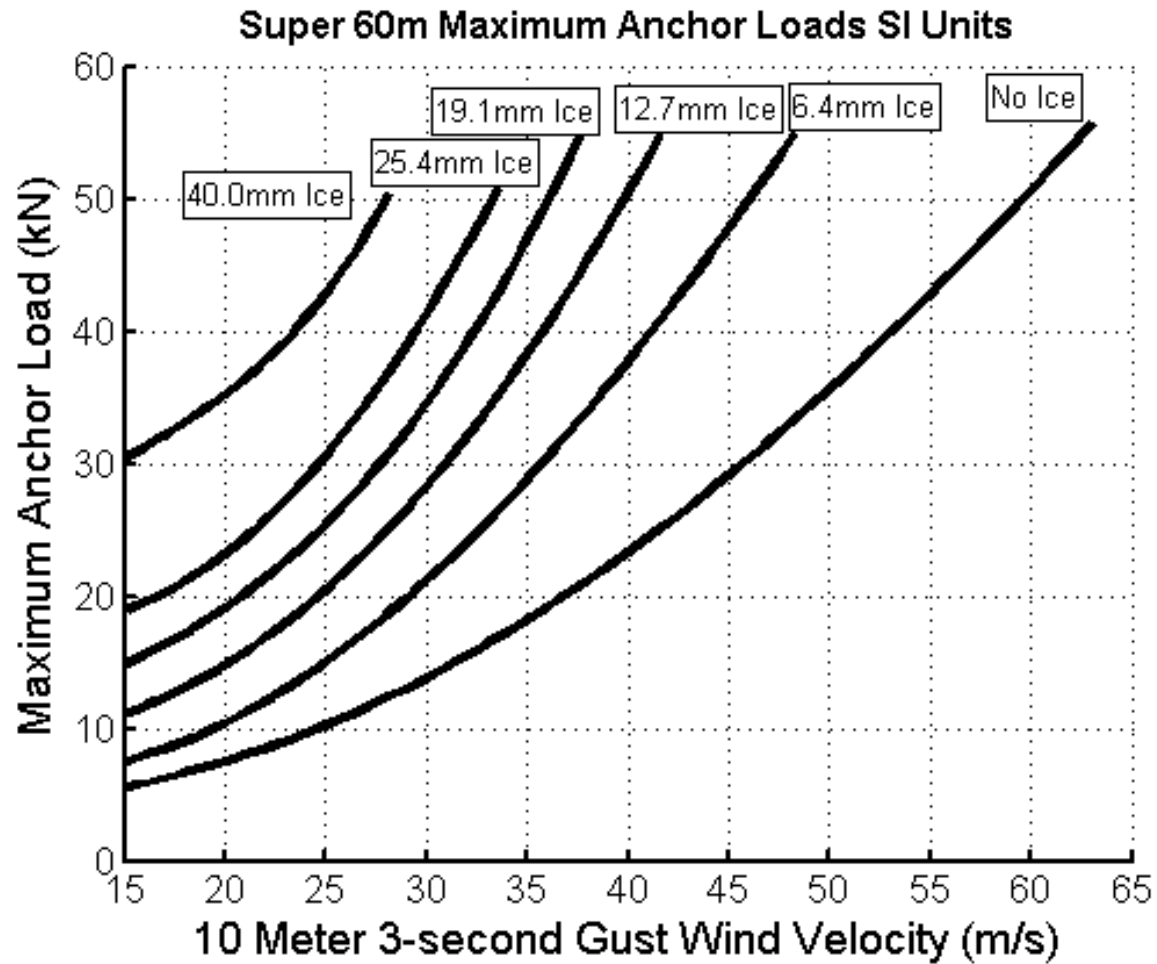

Picture A-7: Super 60 m XHD Maximum Anchor Loads SI Units

BASEPLATE LOADS – IMPERIAL UNITS

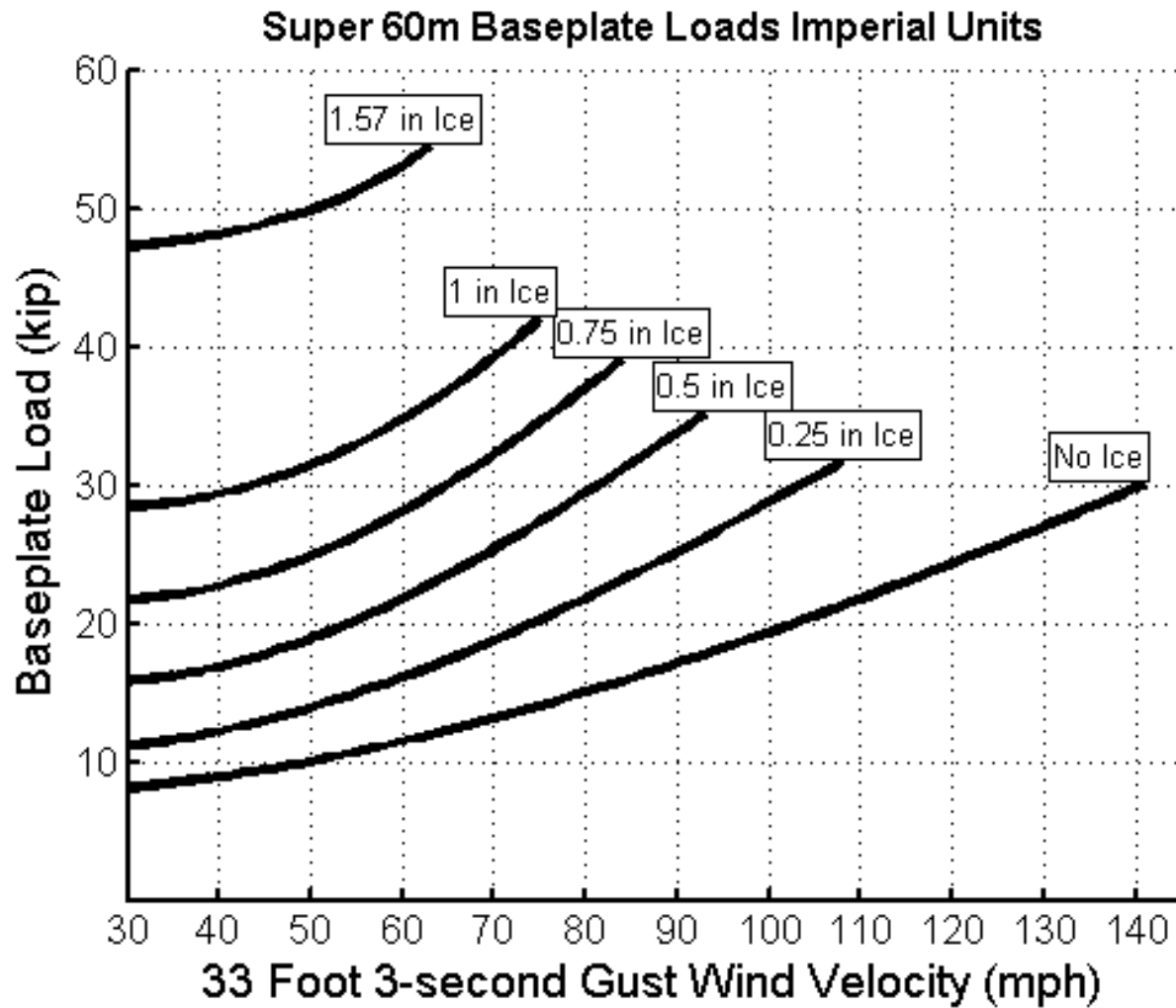

Picture A-8: Super 60m Maximum Baseplate Loads Imperial Units

BASEPLATE LOADS – SI UNIT

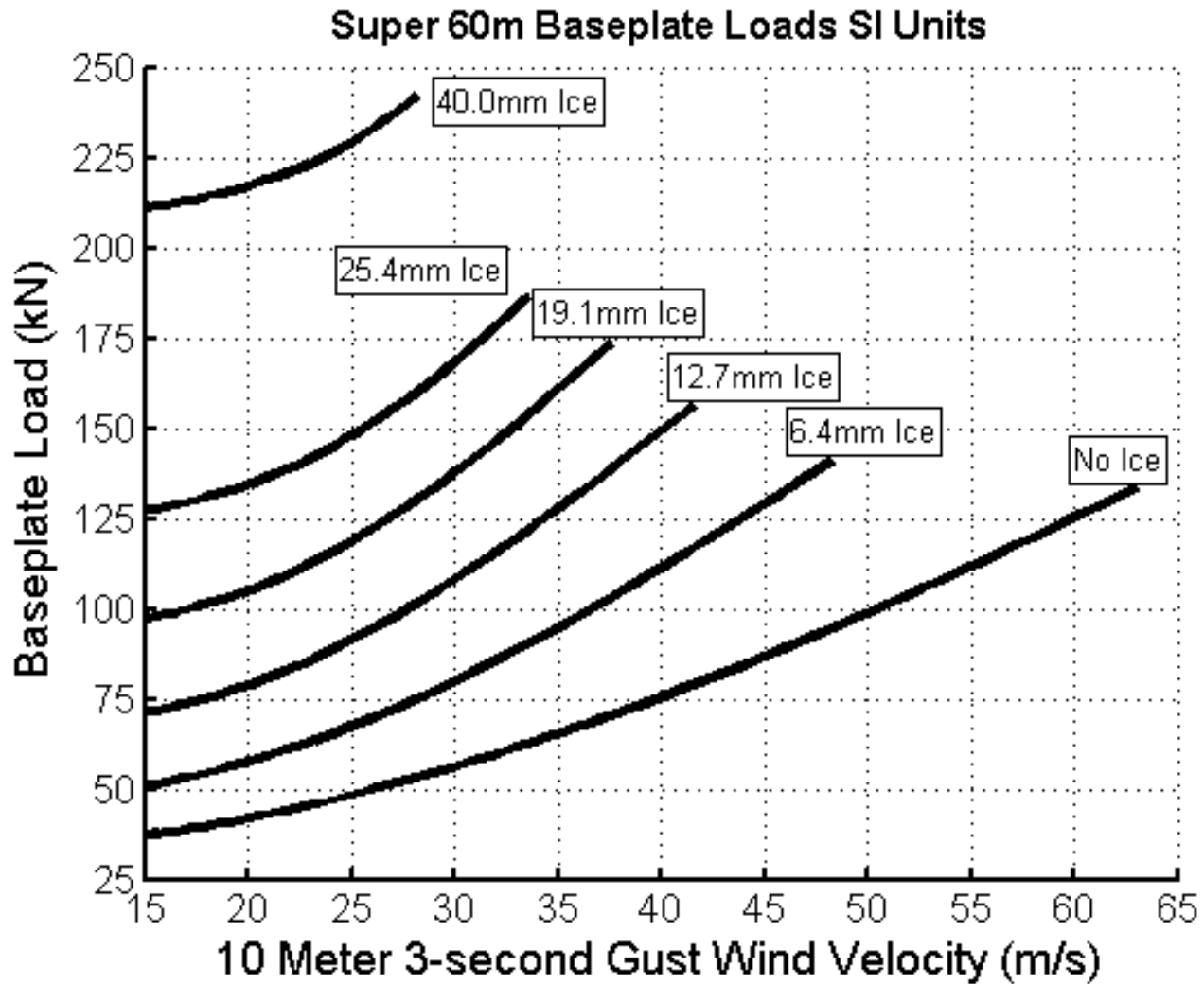

Picture A-9: Super 60m Maximum Baseplate Loads SI Units

## Appendix B: Anchoring Guidelines

### B.1 DETERMINE SITE SOIL AND ANCHOR TYPE BEFORE YOU ORDER YOUR TOWER

Per ANSI/TIA-222-G, for design purposes, one can assume Class 6 soils. However, the Standard requires that soil parameters and assumptions be validated prior to installing the tower.

Before your tower is ordered, determine the soil type, preferably through soil sampling. Order the correct anchors based on the results of the soil sample.

The purpose of this section is to give you the information needed to provide suitable anchoring for your Super 60 m XHD TallTower. **Because anchor requirements are site specific, it is the responsibility of the customer to determine suitable anchors. If you are not sure what is required, seek professional guidance.**

Local utility companies can often provide useful information regarding anchoring used in the site area. Do not use rebar anchors, especially when the surface soils are loose or wet.

**Table B-1: Soil Classes**

Class	Common Soil Types	Geological Soil Classification
3	Dense clays, sands and gravel; hard silts and clays	Glacial till; weathered shales, schist, gneiss and siltstone
4	Medium dense sandy gravel; very stiff to hard silts and clays	Glacial till; hardpan; marls
5	Medium dense coarse sand and sandy gravels; stiff to very stiff silts and clays	Saprolites, residual soils
6	Loose to medium dense fine to coarse sand; firm to stiff clays and silts	Dense hydraulic fill; compacted fill; residual soils
7**	Loose fine sand; Alluvium; loess; soil-firm clays; varied clays; fill	Flood plain soils; lake clays; adobe; gumbo; fill

\*\* In class 7 soils, it is advisable to place anchors deep enough to penetrate underlying class 5 or 6 soil. Charts reproduced by permission, The A.B. Chance Company.

## B.2 ANCHOR CHOICES AND OTHER CONSIDERATIONS

The choice of anchors must take into consideration soil type, maximum winds expected, icing or other weather that may affect the tower, and a safety factor suitable for the location and to meet any legal requirements. Considerations include but are not limited to: tornadoes, hurricanes or typhoons, locations where very high winds are expected, potential for flooding or periodic soaking of the soil, soil erosion, and icing events.

### B.3 Screw-In Anchor Description

Screw-in anchors are the most commonly used anchors for normal clay soils without rocks. The 8 inch single helix anchors are installed by hand, using a cross bar to screw them into the earth like a corkscrew. The 8 inch twin helix anchors require machinery.

The Super 60 m XHD tower employs two (2), 8 inch diameter screw-in anchors and sixteen (12), 8 inch twin helix anchors.

**Table B-2: Specifications for 203 mm (8 inches) diameter Screw-In Anchors**

Length Overall:	<b>203 mm (8 inches) Anchor</b>
Helix diameter:	203 mm (8.0 inches)
Length Overall:	1.65 m (66 inches)
Rod diameter:	25 mm (1 inch)
Material:	Galvanized steel
<b>Holding Power:</b> (These anchors are not suitable for soils denser than class 5.)	
Class 5 soils *	44.5 kN (10000 pounds)
Class 6 soils *	31.1 kN (7000 pounds)
Class 7 soils **	17.8 kN (4000 pounds)

\* See Table for soil class descriptions

\*\* In class 7 soils, it is advisable to place anchors deep enough to penetrate underlying class 5 or 6 soil.

**Table B-3: Specifications for Mid-Strength 203 mm (8 inches) diameter Twin Helix**

Length Overall:	2.7 m ( 9 feet) (including 7 foot rod)
Helix Diameter:	203 mm (8.0 inches)
Materials:	TBD
<b>Holding Power:</b>	
Class 3 soils *	12700 kg (28000 pounds)
Class 4 soils *	10900 kg (24000 pounds)
Class 5 soils *	9090 kg (20000 pounds)
Class 6 soils *	6800 kg (15000 pounds)
Class 7 soils *	5450 kg (12000 pounds)

\* See Table 13 for soil class descriptions

\*\* In class 7 soils, it is advisable to place anchors deep enough to penetrate underlying class 5 or 6 soil.

## B.4 ROCK ANCHOR DESCRIPTION

Rock anchors are placed into solid rock, when anchoring to either bare rock, or thin soils with solid rock near the surface. They are constructed of a threaded rod with integral eye, and two opposing wedge halves. The anchor is placed in a hole pre-drilled in the rock. Twisting the eye of the anchor forces the wedges against the sides of the hole and locks the anchor in place. Load actually increases the wedging force, developing holding power equal to the full tensile strength of the rod.

**Table B-4: Specifications for Rock Anchors**

Holding Power:	9072 kgf (20,000 pounds)
Rod Length Overall:	0.38 m (15 inches), 0.76 m (30 inches) or 1.35 m (53 inches), other lengths available
Anchor Diameter:	44 mm (1.75 inches) as supplied, 60 mm (2.375 inches) max. expanded
Rod Diameter:	19 mm (.75 inches)
Materials:	Malleable iron, dipped in rust-resisting black paint
Required Hole Size:	50 mm (2 inches) diameter (nominal)
Use Rock Drill Size:	50 mm (2 inches) diameter

## B.5 INSTALLING SCREW-IN ANCHORS

Note: Unlike a tent stake, screw-in anchors are installed in line with the pull of the guy wires from the tower. It is important to install the anchor at an angle, so the eye of the anchor is toward the tower and the helix screws in away from the tower.

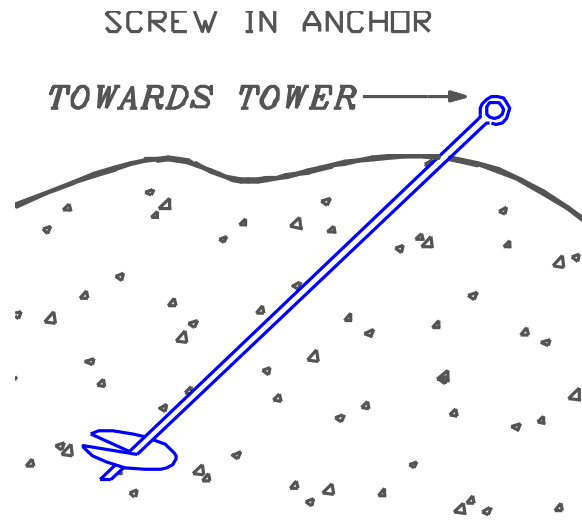

**Picture B-1: Installing Screw-in Anchors**

Screw the anchor into the ground by placing a stout bar through the eye of the anchor, and rotating clockwise. It is sometimes helpful to start the anchor into the ground straight down for the first turn, then push it down to the correct angle and complete the installation. Continue screwing the anchor into the ground until about 150 mm (6 inches) of the anchor rod remains above the ground.

If the anchor cannot be installed due to rocks in the soil, or other obstacles, try placing the anchor as much as 1 m (3 feet) from its ideal position to avoid the obstacle, or replace the screw-in anchor with the correct anchor for the soil. Arrowhead anchors are often suitable for rocky soils.

If necessary, a hole can be dug for the screw-in anchor to the proper installed depth, the anchor placed in the hole, and the hole back-filled. The earth must be tamped onto the anchor hard while back filling. The holding power of an anchor placed this way will not be as great as an anchor screwed into undisturbed soil. If in doubt, get professional advice on whether this option will work for your site.

### B.6 INSTALLING 8 INCH DIAMETER TWIN HELIX ANCHORS

The installation of the 8 inch diameter twin helix anchors requires machinery capable of delivering working torques of 8135 N-m (6000 ft-lbf).

NOTE: All twelve (12) 8 inch diameter twin helix anchors employed on the Super 60 m XHD TallTower must be pull tested to 66.7 kN (15,000 lbf).

Note: It is important to install the anchor at an angle, so the eye of the anchor is toward the tower and the twin helix anchor points away from the tower. If the anchor is incorrectly installed straight into the ground, the load will bend the rod and pull it through the ground, allowing the guys to go slack. The installation tools required to install the twin helix anchors is shown in Picture 107.

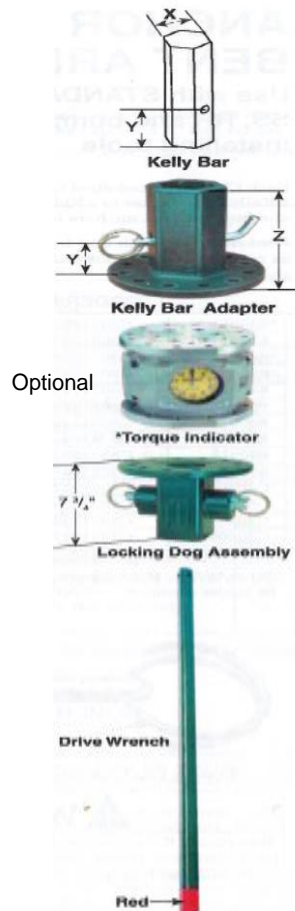

Picture B-2 Drive Wrench and Anchor Rod



The drive wrench slides over the anchor rod and mates with the twin helix anchor, as shown in Picture B-3. The square cross section of the driver wrench permits torque transfer to the anchor for installation and, if necessary, backing-out the anchor while installing.

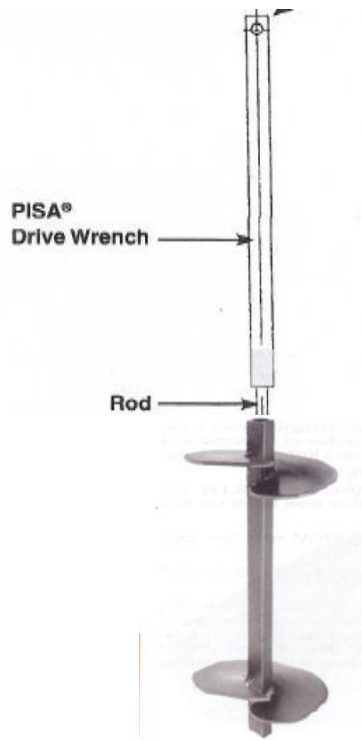

**Picture B-3 Drive Wrench and Anchor Rod**

## **B.7 INSTALLING ROCK ANCHORS**

Rock anchors are used when anchoring to either bare rock or thin soils with solid rock near the surface. Like any anchor, rock anchors must be placed so the force from the guy wires pulls directly on the anchor. Drill the hole for the anchor away from the tower at an angle into the ground.

Note: It is important to install the anchor at an angle, so the eye of the anchor is toward the tower and the expanding part of the anchor points away from the tower. If the anchor is incorrectly installed straight into the ground, the load will bend the rod and pull it through the ground, allowing the guys to go slack. Refer to the appropriate stamped drawing in the Appendix to determine the angle of the tower guys from the ground.

To install the anchor, a hole must be pre-drilled in the rock by hand or power tool. The hole must be 50 mm (2 inches) in diameter, and the walls of the hole should be smooth in the area that the anchor will wedge.

Place the anchor in the hole. Using a bar through the eye of the anchor, turn clockwise to tighten. The anchor will expand and wedge into the hole.

After placing the anchor, fill the hole around the rod with expanding cement grout. One brand is “Rockite” made by Hartline Products Co, Cleveland, OH, USA (telephone: +216 291 2303). Always grout rock anchors to prevent water from collecting and freezing in the drilled hole. Grouting also increases the anchor’s holding strength.

## Appendix C: Site Visit Procedures

### C.1 SITE CHECKLIST

*When making a site visit, check the following:*

- Make sure the tower is straight. Stand at the base of the tower and look up to identify any bowed sections or curves in the tower that may have developed since the tower installation. Carefully adjust guy wires as necessary to straighten the tower.
- Check guy wires for excessive slack and adjust as necessary following the section entitled
- *4.2.2 Adjusting Guy Wires*. It is normal for guy wires to stretch over time, and it is especially important to adjust them before they are subjected to icing or high winds.
- Check each anchor for movement or loosening. A loose anchor can also cause excessive slack in guy wires.
- Check that mounting booms, cellular antennas, temperature sensors, etc. are securely attached.
- Confirm that all grounding connections on the tower and on the logger are secure and haven't corroded.
- Check instantaneous sensor readings on each channel of your data logger. Any sensor providing erroneous readings should be disconnected from the logger and tested independently and/or replaced. It is a good idea to always have spare sensors, memory cards, batteries, and a spare data logger!
- Change the data logger's batteries. Remember that batteries are cheap, and old batteries can leak or cause damage to the logger's SD card – it's better to change them prematurely rather than risk losing data or damaging your measurement equipment!

# Appendix D: Super 60 m XHD TallTower Painted Version

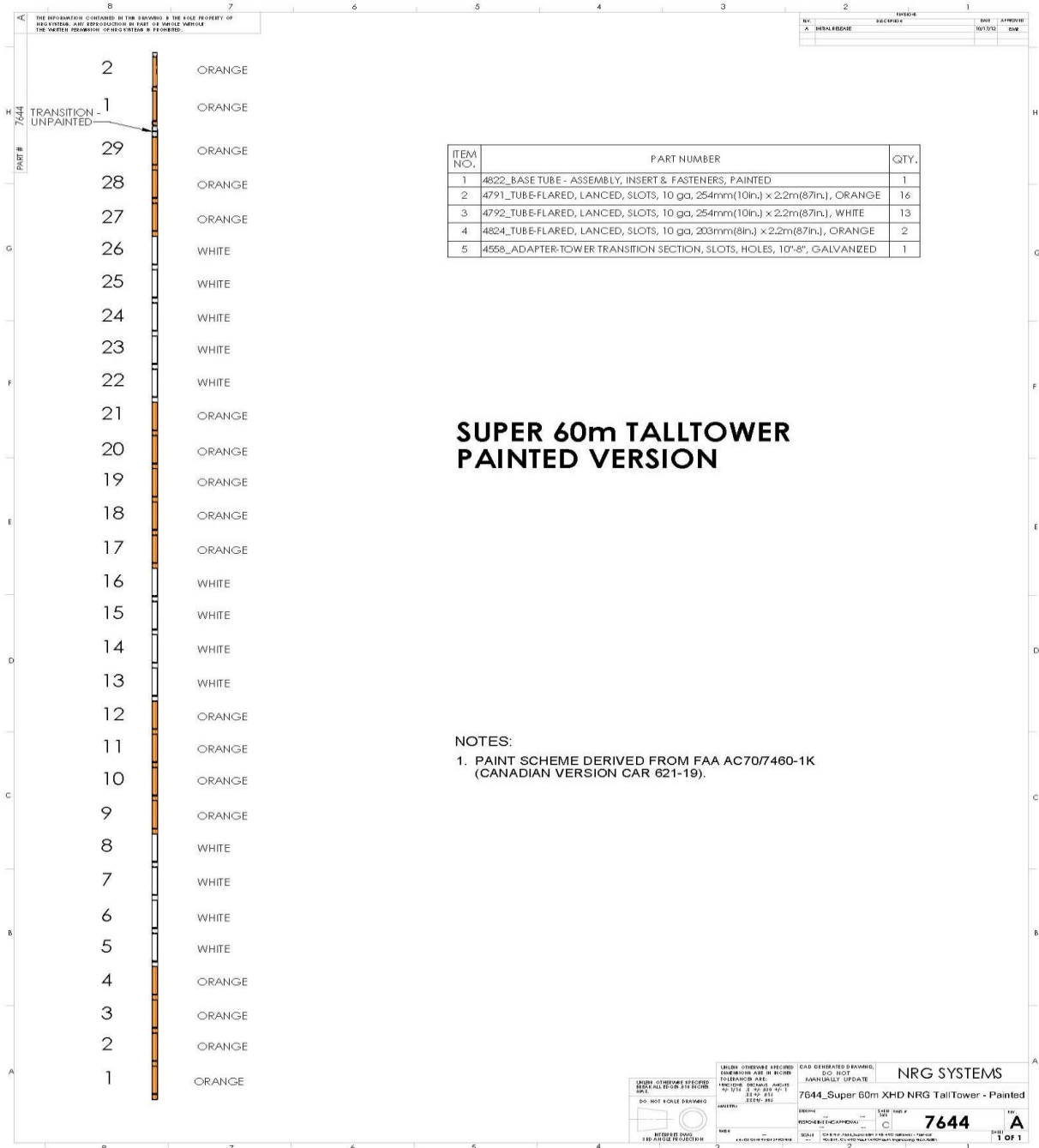

# Appendix E: NRG Super 60 & 80m XHD TallTower Back Guywire Tensioner Assembly and Operating Instructions

## E.1 INTRODUCTION

This procedure requires that during the assembly of the tower, the back guy wires are attached to their respective guy ring, rolled out alongside the tower and measured, then marked at the distances shown in Table E-1. Once marked, connect the back guywires to their respective back guy anchor so that the mark is at the triple eye of the anchor.

**Table E-1: Back Guywire Marking Distance from Guy Level**

Level	Marking Distance from Guy Level (ft [meter])
L1 (Lower)	151 [46.0]
L2	161 [49.1]
L3	175 [53.3]
L4	206 [62.8]
L5	227 [69.2]
L6	251 [76.5]

## E.2 BACK GUYWIRE TENSIONER SYSTEM OVERVIEW

The back guywire tensioner kit consists of two (2) independent systems each comprised of three (3) worm gear winches for the Super 60 meter tower and four (4) worm gear winches for the 80 meter tower. Each are tied to load scales and ganged together using a steel spreader bar. Each system is anchored to a six (6) inch diameter single helix screw-in anchor placed in-line with the outer side-guy anchor 55m [180'-5.4"] ± 2m [6'-7"] from the tower base and 35m [114'-10"] ± 2m [6'-7"] in the direction towards the back anchors. The position of the back guywire tensioners is outside of the side guywire shadow and fall zone of the tower. One set of worm gear winches controls tension on back guywires 1, 3, 5, and 7; the other set controls tension on back guywires 2, 4, 6, and 8. For the Super 60m XHD TallTower, levels 1, 3, and 5 are controlled by one set of worm gear winches, while levels 2, 4, and 6 are controlled by the other set.

Each of two (2) back guywire tensioner system consists of the following parts:

- 6 inch diameter single helix anchors (1)
- Anchor wire rope assemblies (2):
  - Used to connect spreader bar to anchor
  - ¼" wire rope clips (4) used to attach wire rope to anchor
  - ½" shackles (2) used to attach thimbles to spreader bar
- Steel spreader bar (1)
- 0 - 500 lbf load scales:
  - 80m XHD TallTower QTY (4)
  - Super 60m XHD QTY (3)

- Worm gear winches:
  - 80m XHD TallTower QTY (4)
  - Super 60m XHD TallTower QTY (3)
- Leader lines:
  - 80m XHD TallTower QTY (4)
  - Super 60m XHD TallTower QTY (3)
  - Attach worm gear winches to back guywires using the supplied Easy-Feed pulleys
    - 80m XHD TallTower QTY (4)
    - Super 60m XHD TallTower QTY (3)
- 3/16" wire rope clips (8)
  - Used to connect the Leader lines through pulleys attached to the worm gear winch cables

Picture E-1 shows a complete set-up of one of the back guywire tensioner system of the 80m XHD TallTower.

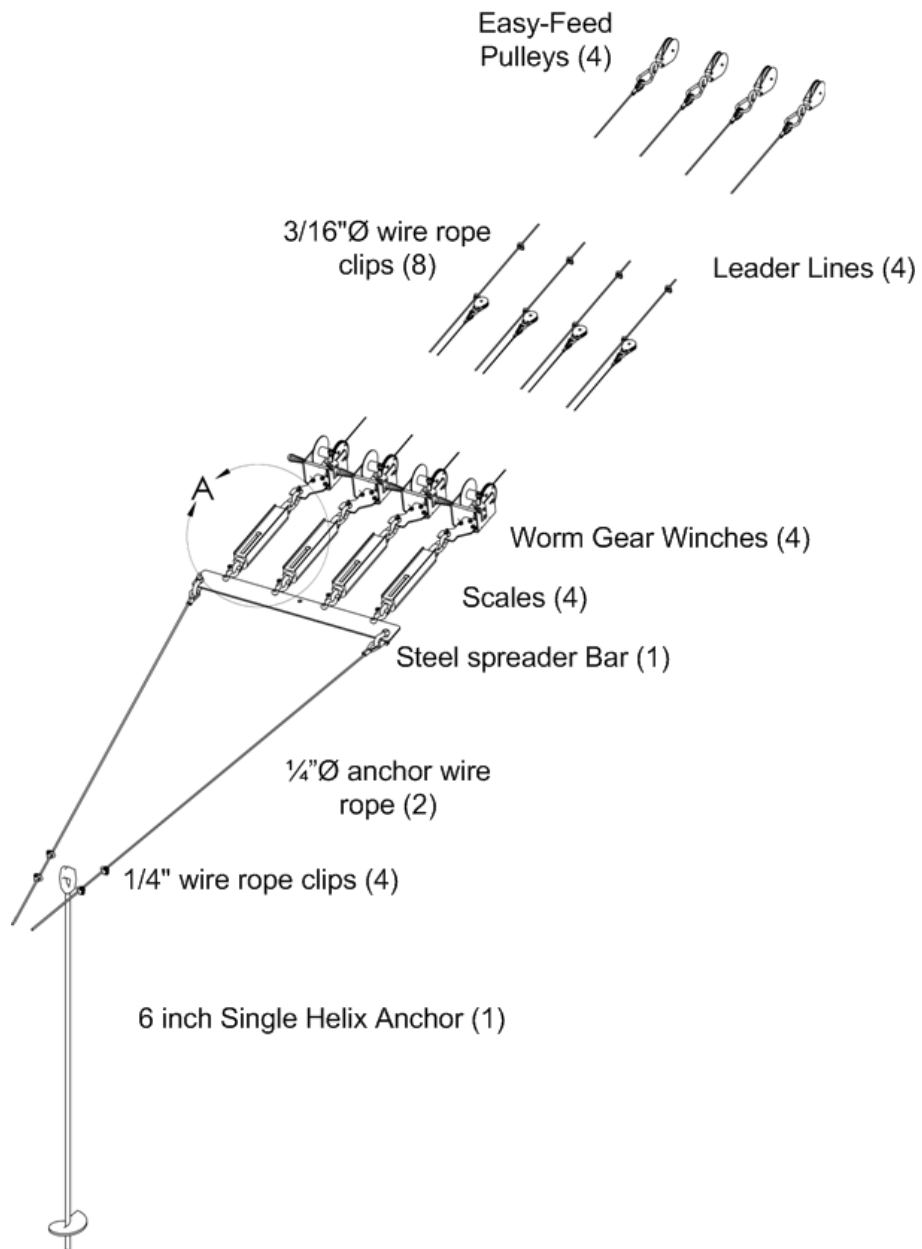

**Picture E-1: Back guywire tensioner system**

Picture E-2 shows a detailed view of the load scale and its connection to the spreader bar and winch plate.

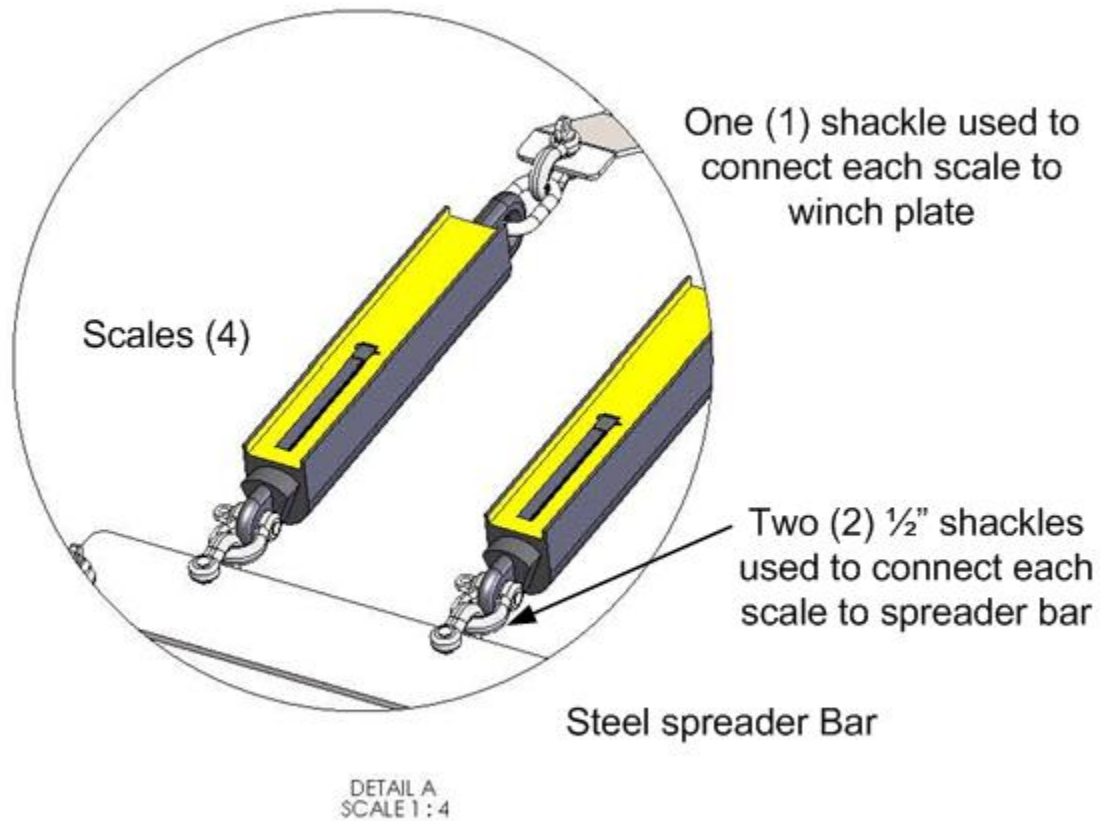

Picture E-2: Zoomed view of scale connection to winch plate and spreader bar

### E.3 BACK GUYWIRE TENSIONER ASSEMBLY

A plan view of the tower layout showing the placement of the back guywire tensioners is included in Picture E-3. Install the two (2) 6 inch diameter single helix screw-in anchors in-line with the outer side-guy anchor 55m [180'-5.4"] ± 2m [6'-7"] from the tower base and 35m [114'-10"] ± 2m [6'-7"] in the direction towards the back anchors.

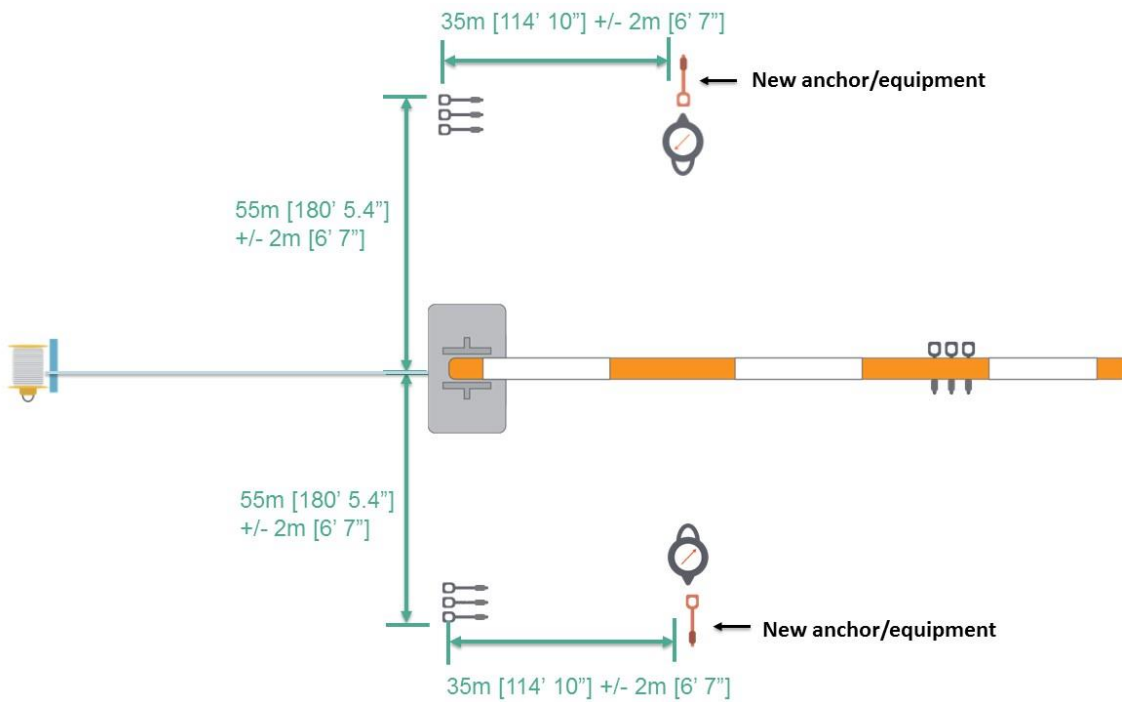

**Picture E-3: Layout drawing showing placement of Back Guywire Tensioners/anchors**

Perform the following set-up instructions:

- Attach the steel spreader bar to the 6 inch diameter anchors using the supplied 1/4" diameter anchor wire rope assemblies and 1/2" shackles.
- Attach the load scales and worm gear winches to the steel spreader bar. Make sure that the scales are set to zero using the adjustment mechanism. Make the zero adjustment with the scale oriented horizontally.
- Roll out leader cables and attach to back guywires using the supplied easy-feed pulleys. Picture E-4 shows the connection of the easy-feed pulleys to the back guywires (disregard the angular position of the tower in the photograph – your tower is on the ground at this point in the lift).
- Leader cables can be installed during initial layout, before lift. Leaders will have to go under all side guys and not over any side guys, front guys, or lifters.





**Picture E-4: Leader cables attached to back guywires using pulleys**

#### **E.4 TOWER LIFT**

The tower lift consists of two (2) distinct phases:

- Phase 1: Tower Lift from  $0^{\circ}$  to  $60^{\circ}$
- Continuous lift
- Phase 2: Tower Lift from  $60^{\circ}$  to  $90^{\circ}$
- Incremental lift
- A graphical depiction of the two (2) phases of the lift is depicted in Picture E-5.
- Below is a detailed description of each the the two (2) phases.

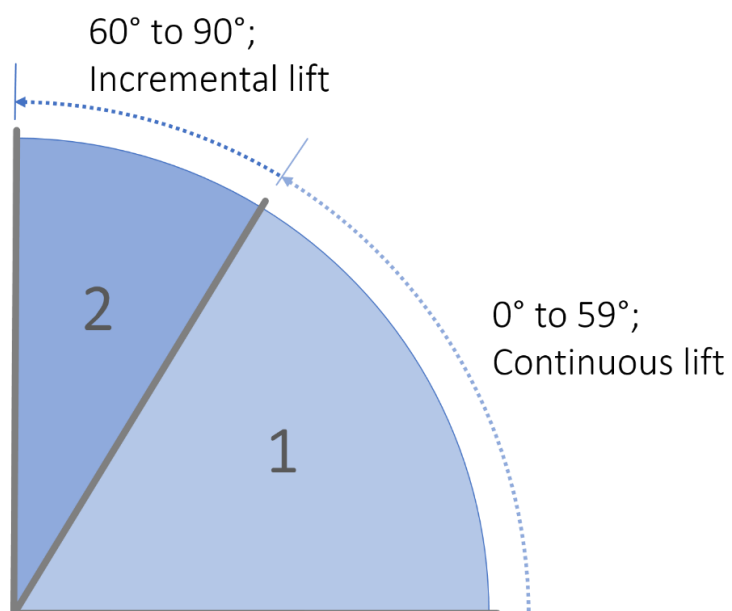

**Picture E-5: Phases of the Super 60 & 80m XHD TallTower lift**

#### **E.4.1 Phase 1: Tower Lift from 0° to 60°**

Raise the tower from 0° to 60° following the same procedure described in the NRG 80 meter XHD TallTower™ Installation Manual & Specifications.

#### **E.4.2 Phase 2: Tower Lift from 60° to 90°**

Above 60° from horizontal, the tower is raised incrementally using the Back Guywire Tensioner system following a revised Lift Cycle described below. The worm gear tensioners replace personnel applying resistance using ropes and carabiners to the back guywires. The Back Guywire Tensioner system also replaces the Lift-Slack (i.e., “Inch-Worm”) method.

Allocate the crew to perform the following tasks:

- Crew Leader (1) to monitor and supervise the tower lift, monitor back guy wire tension at end of lift
- Crew member to monitor and control worm gear winch back guywire tensioners (2)
- Crew member to monitor and control side guywire tension (2)
- Crew member to operate winch (1)

When the tower is at 60 degrees from horizontal, stop the lift. As shown in Picture E-7, attach the leader lines to the worm gear winches using the following instructions:

- Using a cordless drill with a ¾” nut driver, reel out the worm gear winch line about 10 feet and attach the leader cable.
- Feed the leader line cable through the easy-feed pulley affixed to the worm gear winch. Keep some tension on the winch line to prevent unspooling.
- Remove slack and secure the leader line with the supplied wire rope clips. Run winch as-required to place tension (40 ± 10 lbf) on the cable. Attach all eight (8) worm gear winches in the same manner. Refer to Picture E-7, Picture E-8, and Picture E-9 for graphical and pictorial details.

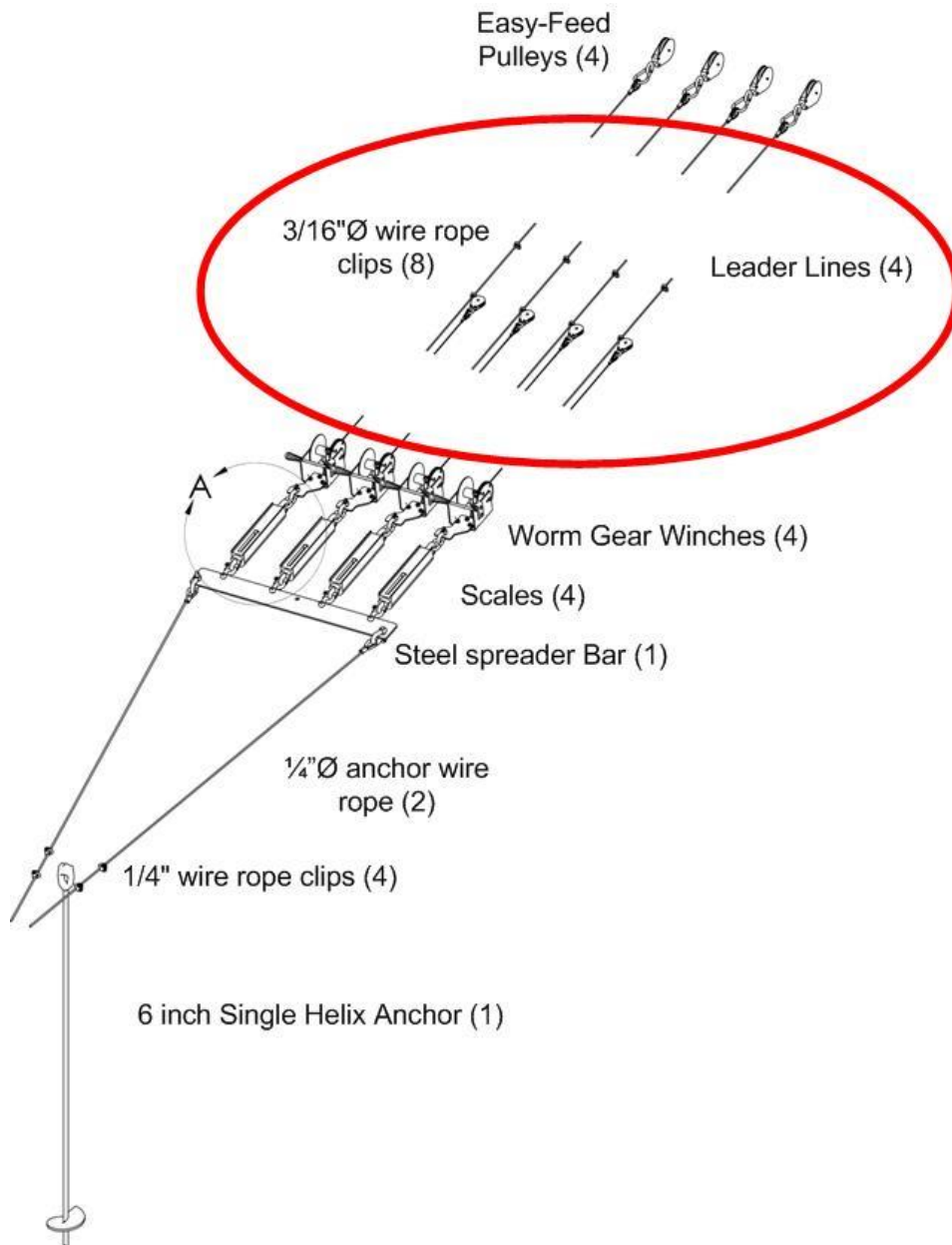

**Picture E-7: Connecting the worm gear winch cables to the leader lines (Picture shows 80m tower set-up using 4 worm gears on each side. Super 60 utilizes 3 worm gears on each side).**

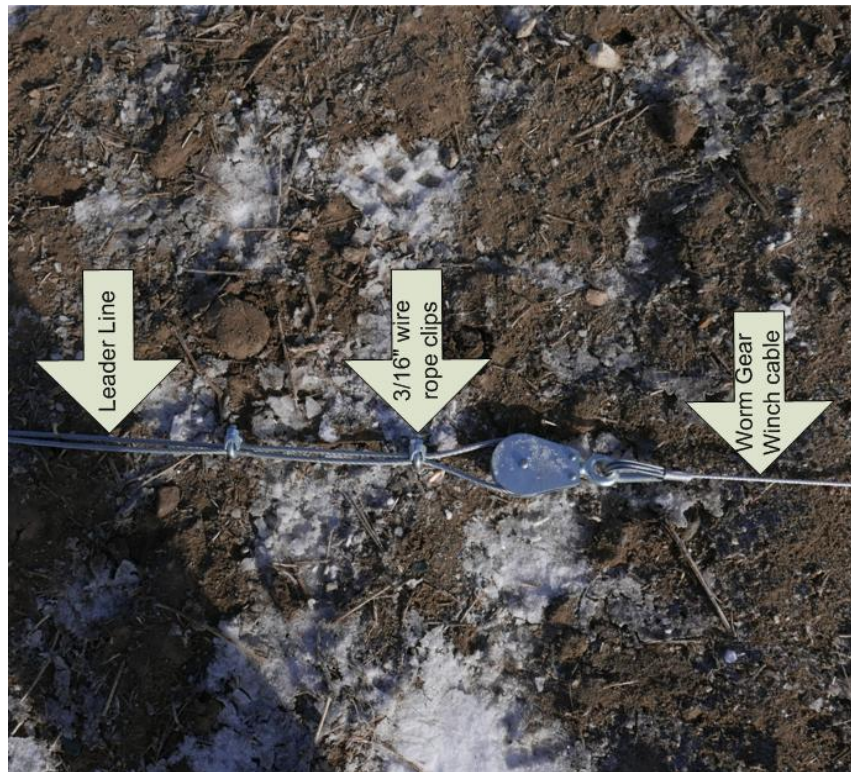

**Picture E-8: Connecting the worm gear winch cables to the leader lines**



**Picture E-9: Set-up of Back Guywire Tensioner (Picture shows 80m tower set-up using 4 worm gears on each side. Super 60 utilizes 3 worm gears on each side).**

### E.4.3 Lift-Cycle Instructions

Once the leader lines are connected to the worm gear winches, prepare to raise the tower following the Lift Cycle procedure:

- Set the initial tensions on the worm gear winches to the loads shown in Table E-2 and indicated on the load scales. As a goal, aim to have the forces within  $\pm 10$  lbf of the target listed in the table.

**Table E-2: Worm Gear Winch Tensions – Start of Lift Cycle**

Back Guywire Level	Worm Gear Tension (lbf)
1, 2 (Lower)	60
3, 4	50
5, 6	40

The tensions listed in Table E-2 are the starting loads in the Lift Cycle. Above 60°, throughout the lifting process, a minimum of 50 lbf shall be applied to the first four back guywire levels at all times.

- When the crew is ready, begin raising the tower. Personnel operating the worm gear winches shall closely monitor the load scales and SIGNAL to STOP the LIFT when the maximum forces have been achieved in any one of the load scales. Pay attention to the load scales as the load increases quickly above 150 lbf. The maximum force at which the lift cycle is stopped is:
  - 200 lbf when the Tower is between 60° to 80°
  - 150 lbf when the Tower is above 80°
- The typical tower movement will be between 0.5° to 2° for each lift cycle.
- A crew member stationed near the back anchor out of the fall zone shall continuously monitor the back guywires to make sure the tension is within acceptable limits.
- After the lift cycle has stopped, reduce the loads by spooling out the worm gear winch lines so that the forces read by the load scales return to the starting loads listed in Table E-2. Typical spool out distances will be on the order of 1 foot on leader line 1 (serving back guywire level 1) and extending up to 3 feet on leader line 8 (serving back guywire level 8). *If a lower guy level is spooling out more than 1 foot and the load is not decreasing – STOP. Assess the situation, make sure the tower is in column. Determine the root cause as to why the load is not decreasing with increasing spooling. Correct the cause before proceeding.*
- When both worm gear winch operators signal that they have returned to the starting loads in Table E-2: E-2, the lift cycle is repeated. The lift cycle is repeated throughout the tower lift, beginning when the tower is at 60° and proceeding until the first of the following occurs:
  - The top of the tower is directly over the baseplate (sight with a carpenter’s level or transit – do not guess), OR
  - Back guywire becomes tight before the tower is vertical
    - During the tower lift, depending on the available lengths of the back guywires, one or more back guywires may become tight. The distance between the Easy-Feed pulleys and the tower itself should be greater than ten (10) tower tube diameters. As shown in Picture E-10, back guywire #5 and #8 are too tight – the Easy-Feed pulley on back guywire #5 is approximately three (3) diameters from the tower column; the Easy-Feed pulley on back guywire #8 is approximately eight (8) tower diameters from the tower column. In both cases, these back guywires are too tight and the tower lift should have been stopped when the Easy Feed pulleys were ten (10) tower diameters from the tower column. In Picture E-10, back guywires #4 and #6 are at acceptable tensions.

Picture E-11 shows a tower installation in which all of the back guywires tensions have acceptable tension.

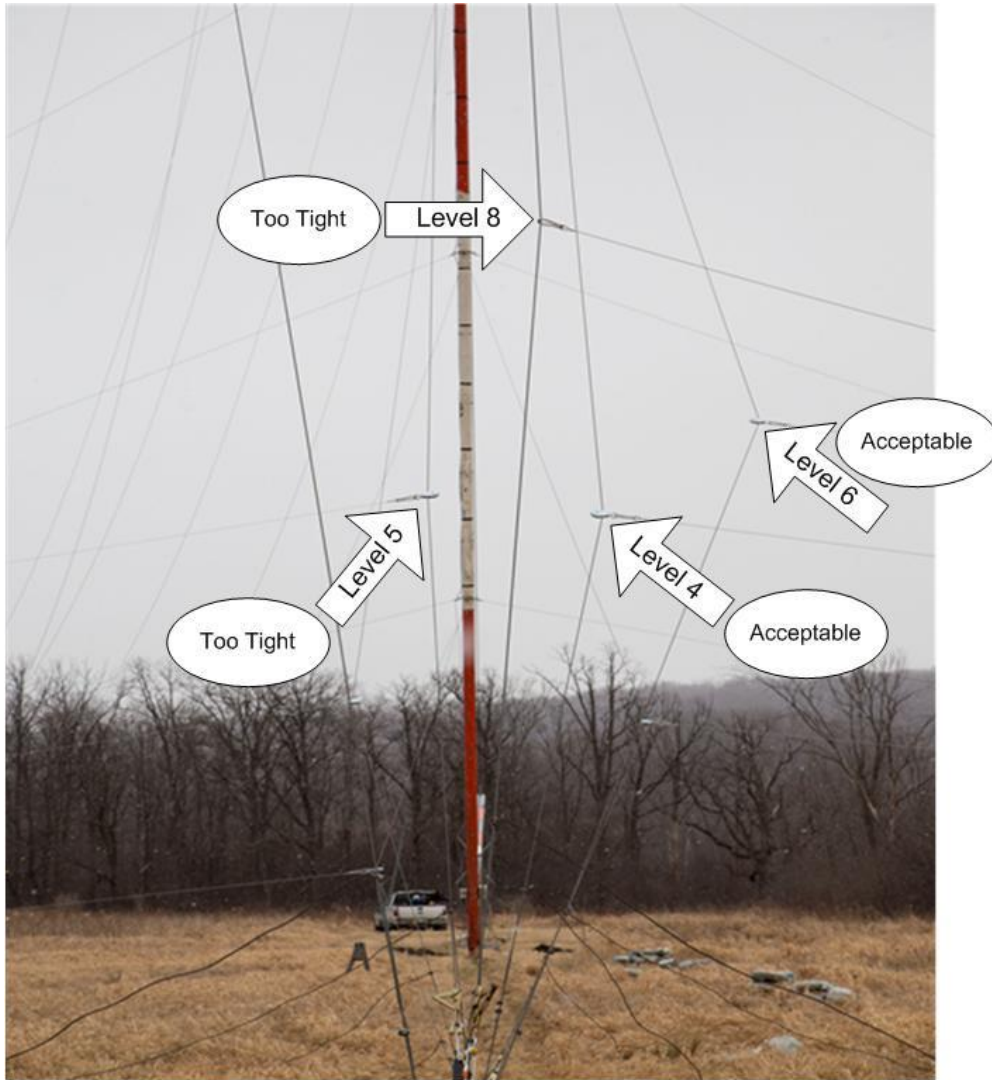

**Picture E-10: View along tower showing acceptable and unacceptable back guywires/leader line tensions (Picture shows 80m tower with 8 back guy wires. Super 60 utilizes 6 back guy wires).**

- Should the back guywires become tight, personnel monitoring the back guywire tension will signal to STOP the lift. Adjust the back guywire tension using the methods proscribed in the Manual. Proceed with the lift using the back guywire tensioners until the tower is directly over the baseplate.
- Check that wire rope clips on the back and side guy wires are secure.

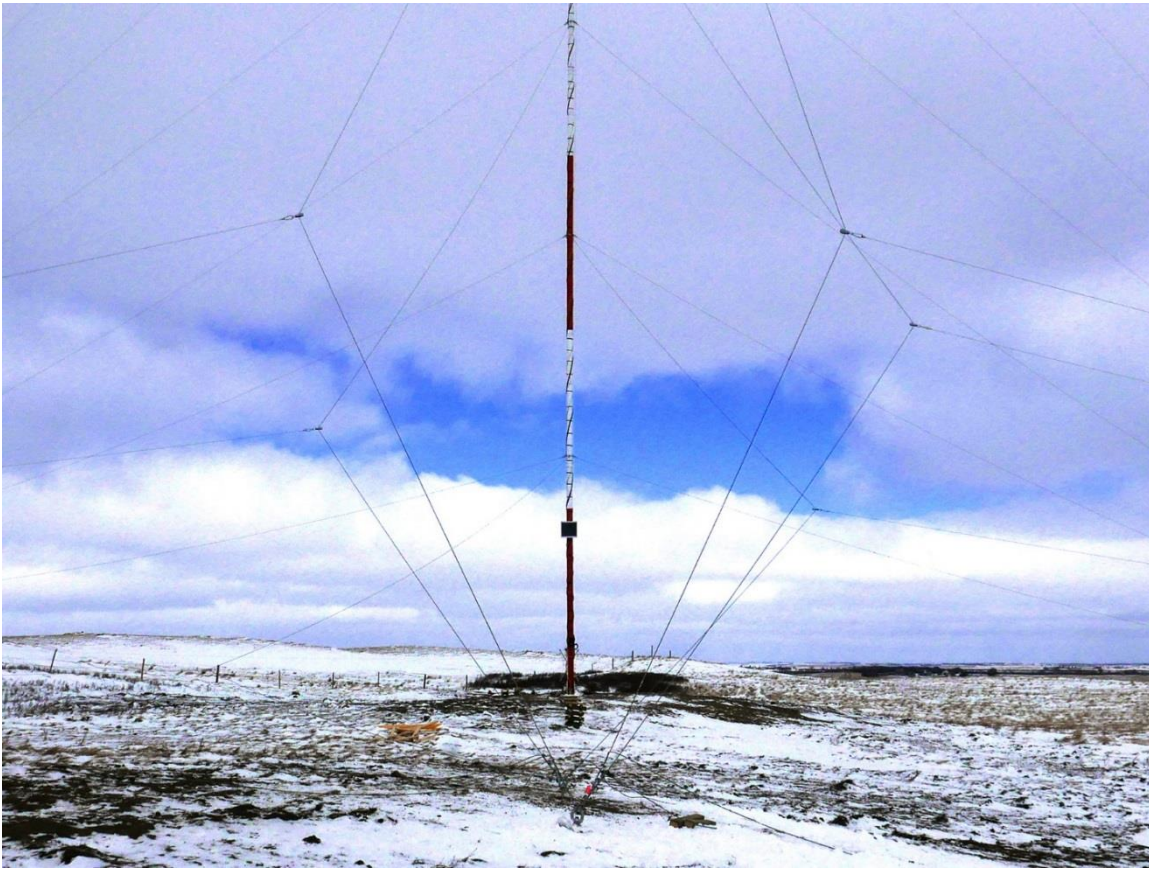

**Picture E-11: View along tower showing acceptable back guywire/leader line tensions**

#### **E.4.4 Attach the Front Guys**

The back guywire tensioner is very useful during the transfer and attachment of the front guywires since it provides constant tension to the back guywires throughout the transfer process. Once the tower is directly over the baseplate, the lift is stopped. Confirm that all side guy wire tension is satisfactory.

Set all 8 load scales ((6) for the Super 60) to  $100 \text{ lbf} \pm 10 \text{ lbf}$  using the worm gear winches. Now, one-by-one, transfer the front guy wires from the ginpole rocker plate to their respective anchors, starting with front guywire #8 (top level on the 80m tower) or #6 (top level on the Super 60m tower) and working down the tower. Each front guywire is tensioned manually at this point. Once all 8 (6 for the Super 60m) front guy wires have been transferred to their respective anchor, the 2 technicians that monitor the worm gear system can return to their stations. The crew leader can now work on plumbing the tower.

#### **E.4.5 Plumb and Straighten Tower**

The back guywire tensioner provides constant tension to the back guywires during the tower plumbing and straightening process. Full instructions on the process for plumbing and straightening your tower can be found in [Chapter 4.5](#).

### **E.5 LOWERING THE TOWER**

The full process of lowering your tower can be found in [Chapter 5](#).

## Appendix F: 2.4 m (95”) Side Mount Boom Installation

### F.1 INTRODUCTION

Side mount booms are used to mount anemometers and wind direction vanes to NRG TallTowers up to 10 inches in diameter. Made of galvanized steel, the 2.4 m (95 inches) boom resists corrosion and holds sensors away from tower to avoid tower shadowing effects. The 2.4 m boom provides horizontal offset of 2.54 m (100 inches) centerline to centerline on a 10” diameter tower (10D), and 2.5 m (99 inches) centerline to centerline on an 8” diameter tower (12.38D). ½ inch mounting stem is 6.5 inches high. Height of cup centerline is 0.38 m (15 inches) (20D) above the ¾ inch boom cross section.

### F.2 INSTALLATION

Step 1: Unpack box – 2 booms, 20 pieces total

Includes:

- 2 mounting brackets
- 6 hose clamps
- (2) 2-part triangular leg assemblies (Part A)
- 2 boom extensions with 90 degree bend – ¾ inch diameter tubing with ½ inch diameter stem shaft (Part B)
- 4 screws for mounting Part A to Part B (2 screws per boom)



Picture F-1

Step 2: Affix Part A to Mounting Bracket

Place mounting bracket on ground or solid surface to install the 2 triangular 5/8 inch diameter boom sections. Line up the 90 degree bend with the large rectangular hole in the mounting bracket as shown in Picture F-2. The large hole in the mounting bracket will go towards the top of the tower.





Picture F-2

Step 3: Position Part A in mounting bracket

The tube will slide into the metal bracket with a firm downward push. There is a metal tab on what will be the bottom side of the mounting bracket - see Picture F-3 for a detailed photo of this tab. Push the 5/8 inch tube to the bottom of the mounting bracket so that the tube hits the metal tab as shown in Picture F-4.



Picture F-3



**Picture F-4**

**Step 4:** Pre-Install the hose clamps into the mounting bracket

Select one hose clamp and feed the free end through one small side hole in the metal bracket, over the boom tubing and out the hole on the opposite side. Position the fastener opposite the mounting bracket on the tower and with the hex head oriented towards you. Repeat 2 more times until all three clamps are in position.

**Step 5:** Install boom on tower

Using a 5/16 inch nut driver, attach the partially assembled boom to the tower. The section with 2 hose clamps will be toward the top of the tower. The hose clamps go around the bracket and the 5/8 tubing. Tighten the top and bottom clamps first, and then tighten the middle clamp. Picture F-6 shows a detailed photo of the bottom clamp assembly. Please note the two metal tabs are toward the base of the tower.



**Picture F-5**

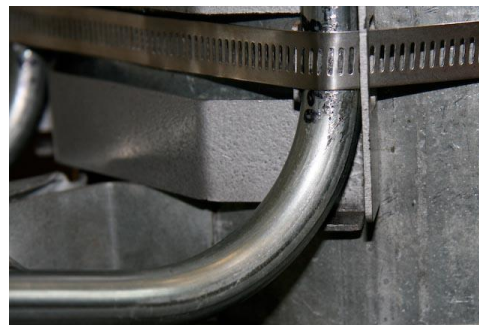

**Picture F-6**

**Step 6:** Locate the 5-holed sleeve on the end of Part A.

The 2 holes for the #10-32 self-tapping screws should be toward the top of the tower. See Picture F-7.



**Picture F-7**

Step 7: Install Part B, boom extension

Insert Part B into the 5-holed sleeve and align with the stem shaft pointing straight up as in Picture F-8.



**Picture F-8**

Step 8: Secure the boom extension

Line up the holes in the  $\frac{3}{4}$  inch pipe with the sleeve. Install the 2 x 5/16 inch drive self-tapping screws in the sleeve (Picture F-9). Using a drill driver and holding it straight helps to get these started correctly and is much more effective than a hand screw-driver.



**Picture F-9**

Tighten the self-tapping screws to secure the boom extension as in Picture F-10. The clutch on the drill driver can be set to a low/medium setting and that will seat the screws correctly.



**Picture F-10**

Picture F-11 shows the finished new boom installed above the 1.53 m (60.5 inch) boom.



**Picture F-11**

## Appendix G: ANSI/TIA-222-G Foundation Considerations

### Baseplate Geometry (with ground surface area of 19.5 ft<sup>2</sup>)

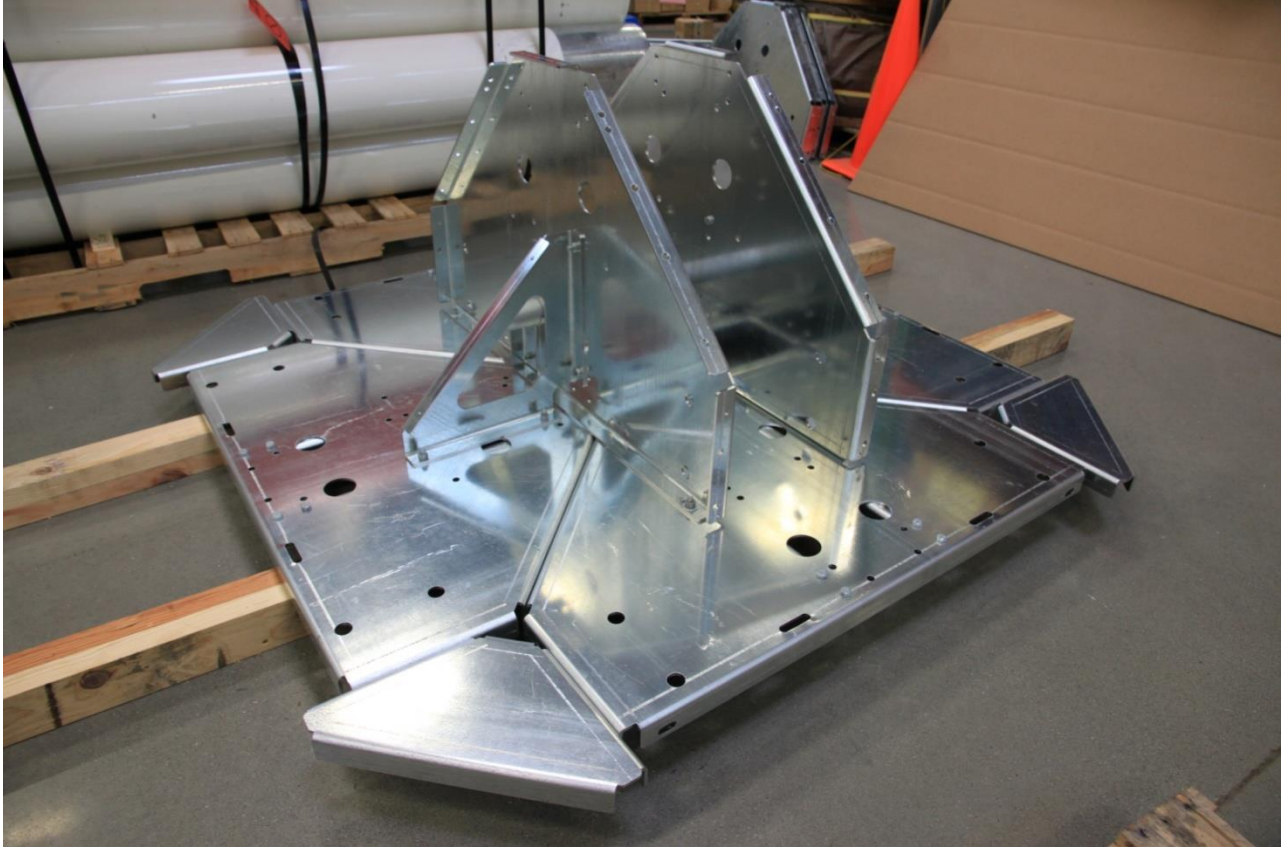

**Picture H-1: Baseplate**

Per

ANSI/TIA-222-G, for design purposes, one can assume Class 6 (Clay) soils. However, the Standard requires that soil parameters and assumptions be validated prior to installing the tower. Prior to tower installation, determine the soil type, preferably through soil sampling.

The baseplate cross-sectional area is 19.5 ft<sup>2</sup>. The cross-sectional area was sized to ensure the factored resistance of Clay soil is greater than the reactions from the factored load combinations listed in section 2.3.2 of ANSI/TIA-222-G. The presumptive soil parameters per ANSI/TIA-222-G assume dry soil conditions. If your soil can develop a significant ice lens (due to poor soil drainage) during freezing, it may be necessary to provide a foundation to ensure adequate bearing strength. Foundation details must be approved for the specific application and site by a qualified professional.